



ProQuatro User Manual

PROFESSIONAL SERIES HANDHELD METER



ProQuatro

The information contained in this manual is subject to change without notice.

Effort has been made to make the information in this manual complete, accurate, and current.

The manufacturer shall not be held responsible for errors or omissions in this manual.

Consult YSI.com for the most up-to-date version of this manual.

Thank you for purchasing a YSI Professional Series Quatro handheld meter. This manual covers setup, operation, and functionality of the ProQuatro handheld.

Safety Information

Please read this entire manual before unpacking, setting up or operating this equipment. Pay attention to all precautionary statements. Failure to do so could result in serious injury to the operator or damage to the equipment. Do not use or install this equipment in any manner other than that specified in this manual.

The manufacturer is not responsible for any damages due to misapplication or misuse of this product including, without limitation, direct, incidental and consequential damages, and disclaims such damages to the full extent permitted under applicable law. The user is solely responsible to identify critical application risks and install appropriate mechanisms to protect processes during a possible equipment malfunction.

Product Components

Carefully unpack the instrument and accessories and inspect for damage. If any parts or materials are damaged, contact YSI Customer Service at 800-897-4151 (+1 937 767-7241) or the authorized YSI distributor from whom the instrument was purchased.

Each ProQuatro handheld is shipped with:

- Quick Start Guide
- USB flash drive with a digital copy of the manual
- Two (2) C-size alkaline batteries
- USB 2.0 cable for connection to a USB flash drive

Precautionary Symbols

NOTE: Information that requires special emphasis

NOTICE: Indicates a situation which, if not avoided, may cause damage to the instrument



CAUTION: Indicates a potentially hazardous situation that may result in minor or moderate injury



WARNING: Indicates a potentially or imminently hazardous situation which, if not avoided, could result in death or serious injury

TABLE OF CONTENTS

1. Getting Started

- 1.1 Battery Use and Battery Life
- 1.2 Sensor Installation and Cable Connection
- 1.3 Connecting the Cable to the ProQuatro

2. Operation

- 2.1 Keypad Layout
- 2.2 Powering On and Main Display
- 2.3 Menu Layout
- 2.4 System Menu
- 2.5 Sensor Menu
 - Setup
 - Display
 - Auto Stable
 - Salinity
- 2.6 Calibration Menu and Procedures
 - Conductivity Calibration
 - Dissolved Oxygen Calibration
 - pH Calibration
 - ORP Calibration
 - Ammonium, Nitrate, and Chloride Calibration
 - Barometer Calibration
 - Restore Default Calibration Values
 - Recalibration Prompt
- 2.7 Files Menu
 - Data Memory
 - Viewing Saved Data
 - View Calibration Records
 - View Data ID List
 - Delete Data
 - Upload Files
- 2.8 Taking Measurements
- 2.9 Instrument Display Range

3. Care, Maintenance, and Storage

- 3.1 General Maintenance
- 3.2 Sensor Maintenance
 - Dissolved Oxygen Sensor Maintenance
 - Conductivity Sensor Maintenance
 - Temperature Sensor Maintenance
 - pH, ORP, and pH/ORP Sensor Maintenance
 - Chloride Sensor Maintenance
 - Ammonium and Nitrate Sensor Maintenance
- 3.3 Sensor Storage

4. Accessories

- 4.1 Ordering
 - Handhelds and Kits
 - Field Cable Assemblies
 - Sensors for Field Cables
 - Lab Cable Assemblies
 - Other Accessories
 - Calibration Solutions
 - Replacement Parts

5. Safety and Support

- 5.1 Service Information
- 5.2 Technical Support
- 5.3 Declaration of Conformity
- 5.4 Warranty

6. Appendices

- 6.1 Appendix A - DO% Calibration Values
- 6.2 Appendix B - Oxygen Solubility Table



THIS IS AN INTERACTIVE DOCUMENT

When viewing this document as an Adobe™ PDF, hovering your cursor over certain phrases will bring up the finger-point icon. Clicking elements of the Table of Contents, website URLs, or references to certain sections will take you automatically to those locations.

1. Getting Started

1.1 Battery Installation

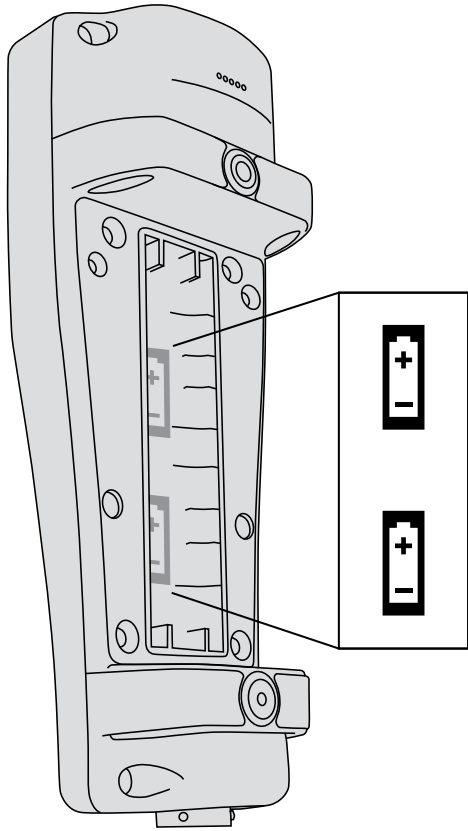

Figure 1 ProQuatro with battery cover removed. Notice the battery symbols indicating polarities.

The ProQuatro requires (2) alkaline C-cell batteries which are included with the purchase of a new instrument. Battery life depends on parameters and usage. Under normal conditions, battery life is approximately 80 hours for continuous use at room temperature. To install or replace the batteries:

1. Turn the instrument over to view the battery cover on the back.
2. Unscrew the four captive battery cover screws.
3. Remove the battery cover and install the new batteries, ensuring correct polarity alignment ([Figure 1](#)).
4. Replace the battery cover on the back of the instrument and tighten the four screws. Do NOT over-tighten.

1.2 Sensor Installation and Cable Connection

There are multiple cables and sensors that can be used with the ProQuatro. Please refer to the following sections to ensure the correct cables and sensors are used with the instrument.

Field Cables and Sensors

Most field cables have at least one sensor port in which a sensor must be installed. Ports on these cables are sensor-specific, so it is important to ensure the correct sensor is installed in each port. Available field cables are listed in the table below:

YSI Item #	Description
605790-1, 4, 10, 20, or 30	Quatro (4 port), Dual ISE/Cond/DO/Temp. A user-replaceable conductivity/temp sensor is included with each cable. There is one DO port and two ISE ports in which sensors can be installed. DO and ISE sensors sold separately. Does not accept 1003 pH/ORP combo sensor.
6052030-1, 4, 10, 20, or 30	DO/Cond/Temp. Includes built-in conductivity and temp sensors. There is one DO port in which a DO sensor can be installed. DO sensors sold separately.
6051030-1, 4, 10, 20, or 30	ISE/Cond/Temp. Includes built-in conductivity and temp sensors. There is one ISE port in which an ISE can be installed. ISE sensors sold separately.
6051020-1, 4, 10, 20, or 30	DO/ISE/Temp. Includes a built-in temp sensor. There is one DO port and one ISE port in which sensors can be installed. DO and ISE sensors sold separately.
6051010-1, 4, 10, 20, or 30	Dual ISE/Temp. Includes a built-in temp sensor. There are two ISE ports in which sensors can be installed. ISE sensors sold separately. Does not accept 1003 pH/ORP combo sensor.
60530-1, 4, 10, 20, or 30	Cond/Temp. Includes built-in conductivity and temp sensors; no additional sensors needed.
60520-1, 4, 10, 20, 30, or 100	DO/Temp. Includes a built-in temp sensor. There is one DO port in which a DO sensor can be installed. DO sensors sold separately.
60510-1, 4, 10, 20, or 30	ISE/Temp. Includes a built-in temp sensor. There is one ISE port in which an ISE can be installed. ISE sensors sold separately. Does not accept 1003 pH/ORP combo sensor.



ISE (Ion Selective Electrode) notates a port that can accept pH, ORP, Ammonium, Nitrate, Chloride, and, in some cases, a pH/ORP combination sensor (6051030 and 6051020 cables only).

Throughout the manual, the term “sensor” refers to the removable portion or electrode sensing portion of the cable assembly. For example, the DO sensor or pH sensor is the part that can be removed from a field cable and replaced with a new sensor. Sensors that are available for field cables include:

YSI Item #	Description
605202	Galvanic DO Sensor
605203	Polarographic DO Sensor
605101	pH Sensor
605102	ORP Sensor
605103	pH/ORP Sensor (for use with 6051030 and 6051020 cables only)
605104	Ammonium ISE, NH ₄ ⁺
605105	Chloride ISE
605106	Nitrate ISE
605323	1001A Amplified pH Sensor
605216	1001A Amplified pH Sensor Kit; includes a required guard extension for 6051010 and 6051020 cables
005560	Conductivity and temperature sensor for Quatro cables; included with new Quatro cables

Dual sensor bulkhead ports are numbered 1 and 2, see figure 2 below. Please refer to the following tables to determine correct sensor installation.

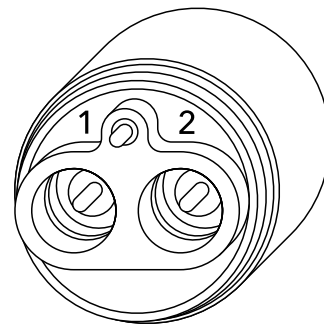

Figure 2 Port numbers on a 2-port cable

Cable	Port 1 Options*	Port 2 Options
1010 dual port cable	pH	pH
	ORP	ORP
	Ammonium	Ammonium
	Chloride	Chloride
	Nitrate	Nitrate
		None (use a port plug)

i *A sensor must be installed in port 1 for correct operation. If you install a pH/ORP combo sensor into a 6051010 cable, ORP will not be measured. It is not recommended to use a pH/ORP combo sensor on a 6051010 cable.

Cable	Port 1 Options	Port 2 Options
1020 dual port cable	pH	Polarographic DO
	ORP	Galvanic DO
	pH or pH/ORP	None (use a port plug)
	Ammonium	
	Chloride	
	Nitrate	
	None (use a port plug)	

i If using a 605103 pH/ORP combination probe with a 6051020 or 6051030 cable, you can report both pH and ORP. However, it is recommended to set ISE1 as pH and ISE2 as ORP in the Sensor Setup menu.

The Quatro cable bulkhead ports are labeled 1, 2, DO, and CT, see figure 3 below. All sensors except the Conductivity/Temperature sensor can be installed following directions in the section Sensor Installation - All Sensors Except the Conductivity/Temp Sensor. The Conductivity/Temperature sensor can be installed using directions in the section Sensor Installation - Conductivity/Temp Sensor in a Quatro Cable. For ease of installation, YSI recommends that you install a sensor into port 1 first; followed by DO installation, then port 2, and lastly C/T.

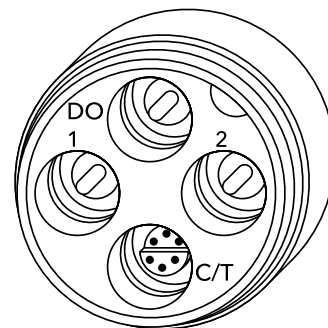

Figure 3 Port labels on a Quatro cable

Cable	Port 1 Options*	Port 2 Options	DO Port Options	C/T Port Options
Quatro cable (605790)	pH	pH	Polarographic DO	5556 Conductivity/ Temperature sensor only (included with new Quatro cables)
	ORP	ORP	Galvanic DO	
	Ammonium	Ammonium	None (use a port plug)	
	Chloride	Chloride		
	Nitrate	Nitrate		
		None (use a port plug)		

i **If using a Quatro cable, a sensor must be installed in port 1 for correct operation of port 2. If you install a pH/ORP combo sensor into a Quatro cable, ORP will not be measured. It is not recommended to use a pH/ORP combo sensor on a Quatro cable.*

Sensor Installation - All Sensors Except the Conductivity/Temp Sensor

First, ensure both the sensor connector and sensor port on the cable are clean and dry. To connect the sensor, grasp the sensor with one hand and the sensor connection end of the cable (bulkhead) in the other. Push the sensor into the connector on the cable until it is properly seated and only one o-ring is visible. Failure to properly seat the probe may result in damage. Twist the sensor clockwise to engage threads and finger tighten (Figure 4). DO NOT use a tool. This connection is waterproof. Please refer to the sensor installation sheet that is included with each sensor for detailed instructions.

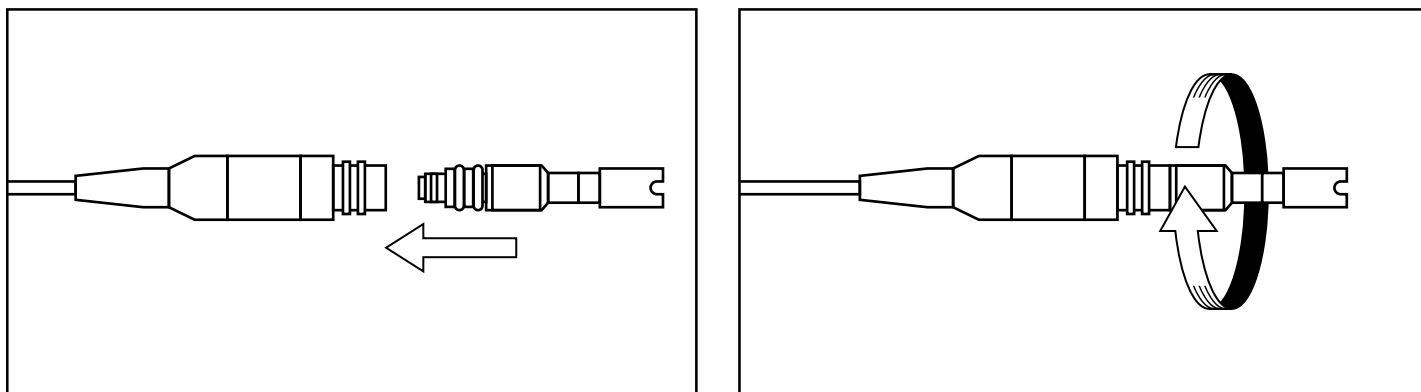



Figure 4 The image on the left shows a clean, dry sensor being aligned with the bulkhead. On the right, the sensor has been pushed into the bulkhead and is being screwed into place.

i *Before installing a dissolved oxygen sensor and connecting the cable to the ProQuatro, the ProQuatro must be configured for the sensor being installed. See the Dissolved Oxygen Sensor Setup section of this manual for instrument configuration instructions. Failure to do this may result in damage not covered under warranty.*

Sensor Installation - Conductivity/Temp Sensor in a Quatro Cable

As mentioned, the installation of the Conductivity/Temperature (C/T) sensor (model 5560) in a Quatro cable is different from all other Pro Series sensor installations. Follow these instructions when installing a conductivity/temperature sensor in a Quatro cable:

1. Locate the C/T port and, if replacing, remove the old sensor using the installation tool to loosen the stainless steel retaining nut. Once the stainless steel retaining nut has been completely unscrewed from the bulkhead, remove the old sensor from the bulkhead by pulling the sensor straight out of the bulkhead.
2. Apply a thin coat of o-ring lubricant (supplied with the sensor) to the o-rings on the connector side of the new sensor.

 *Visually inspect the port for moisture. If moisture is found, it must be completely dried prior to sensor installation.*

3. Align the connectors of the new sensor and the port. With connectors aligned, push the sensor in towards the bulkhead until you feel the sensor seat in its port. You will experience some resistance as you push the sensor inward, this is normal.
4. Once you feel the sensor seat into the port, gently rotate the stainless steel sensor nut clockwise with your fingers. **DO NOT** use the tool.
5. The nut must be screwed in by hand. If the nut is difficult to turn, **STOP**, as this may indicate cross threading. **DO NOT cross thread the sensor nut!** If you feel resistance or cross threading at any point, unscrew the nut and try again until you are able to screw the nut down completely without feeling any resistance. Damage to your cable/ sensor may occur if you force the parts together.
6. Once completely installed, the nut will seat flat against the bulkhead. At this point, use the tool that was included with the sensor to turn the nut an additional $\frac{1}{4}$ to $\frac{1}{2}$ turn (Figure 5). **DO NOT over tighten.**

Please refer to the sensor installation sheet that is included with the conductivity/temperature sensor for detailed instructions.

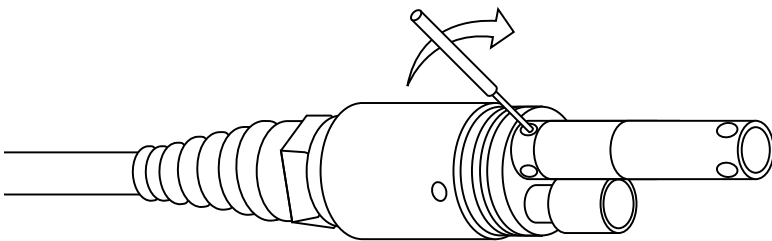



Figure 5 Installation tool used to tighten the stainless steel retaining nut of the C/T sensor.

Port Plug Installation

 *When a sensor is not installed, the sensor and cable sensor connectors are NOT water-proof. Do not submerge the cable without a sensor or port plug installed in all available ports.*

As necessary, install a port plug into any port that does not have an installed sensor. This will protect the bulkhead from water damage. Port plugs and a tube of o-ring lubricant are included with all Quatro cables. These items can be ordered separately if needed. To install a port plug, apply a thin coat of o-ring lubricant to the two o-rings on the port plug. After application, there should be a thin coat of o-ring lubricant on the o-rings. Remove any excess o-ring lubricant from the o-ring and/or port plug with a lens cleaning tissue. Next, insert the plug into an empty port on the bulkhead and press firmly until seated. Then, turn the plug clockwise to engage the threads and finger-tighten until the plug is installed completely. **DO NOT use a tool to tighten the plug.**

Laboratory Cables and Sensors

There are several cable assemblies with built-in sensors that are ideal for use in a laboratory environment. These assemblies include:

YSI Item #	Description
605780	DO/Temp 115V stirring BOD probe with 1-meter cable assembly
605107	pH/Temp single junction combination electrode with 1-meter cable
605177	pH/Temp single junction combination electrode with 4-meter cable
605108	ORP/Temp single junction combination electrode with 1-meter cable
605178	ORP/Temp single junction combination electrode with 4-meter cable
605109	pH/ORP/Temp single junction combination electrode with 1-meter cable
605179	pH/ORP/Temp single junction combination electrode with 4-meter cable

1.3 Connecting the Cable to the ProQuatro

The military-spec (MS) cable connectors are keyed for positive mating and to prevent connector damage (Figure 6). The handheld retains its IP-67 waterproof rating when the cable is disconnected. However, the connectors are not wet-mateable and should be clean and dry before connecting.

Align the keys on the cable connector with the slots on the handheld connector. Push together firmly, then twist the outer ring clockwise until it locks into place.

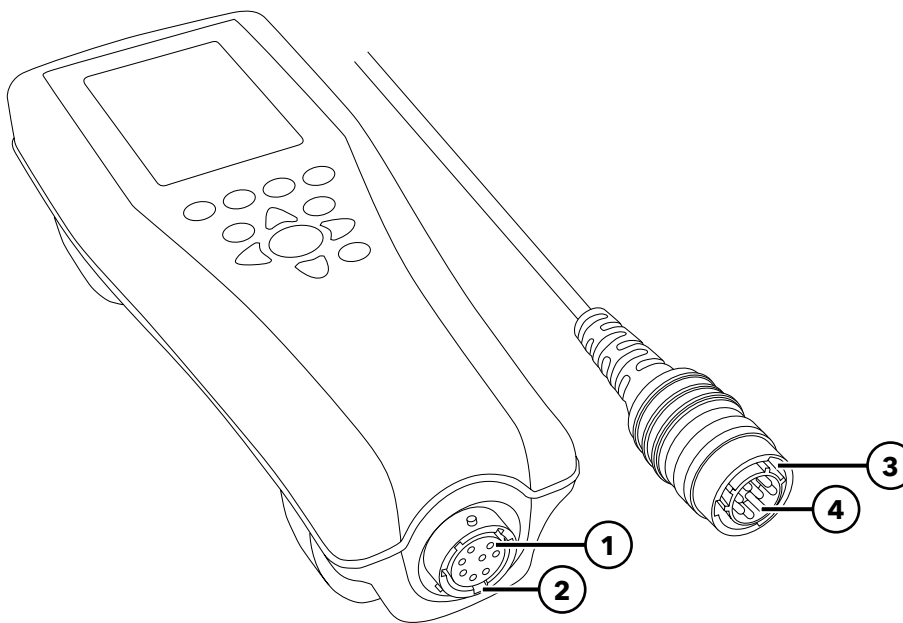

Figure 6 Keyed connectors

1 Handheld female connector	3 Keyed area of connector
2 Slotted area of connector	4 Cable male connector

2. Operation

2.1 Keypad Layout

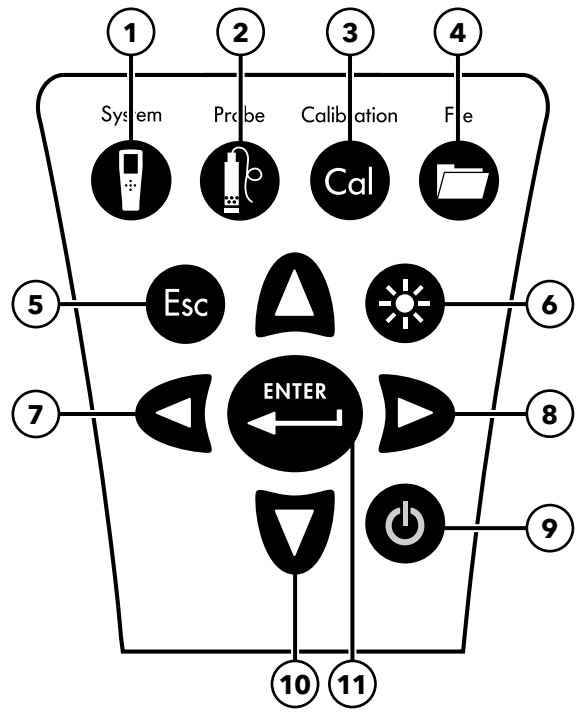

Figure 7 ProQuatro Keypad

1	System: Opens System Menu from any screen. Use to adjust system settings.
2	Probe: Opens Sensor Menu from any screen. Use to enable sensors and display units.
3	Calibrate: Opens Calibrate Menu from any screen. Use to calibrate all parameters except temperature.
4	File: Opens File Menu from any screen. Use to view data and calibration records, set up Data IDs, and delete data.
5	Exit/Escape key: Exits back to Run Screen. When in alpha/numeric entry screen, escapes to previous menu.
6	Backlight: Press to turn the instrument backlight on and off and to adjust the display contrast when pressed with the left or right arrow key.
7	Left arrow key: Use to navigate left in alpha/numeric entry screens. Press to return to previous menu in all screens except alpha/numeric entry. Can be pressed simultaneously with Backlight key to decrease display contrast.
8	Right arrow key: Use to navigate right in alpha/numeric entry screens. Can be pressed simultaneously with Backlight key to increase display contrast.
9	Power: Press to turn the instrument on. Press and hold for 5 seconds to turn off.
10	Up/Down arrow keys: Use to navigate through menus and to navigate down in alpha/numeric entry screens.
11	Enter key: Press to confirm selections, including alpha/numeric key selections. When on the Run screen, pressing the Enter key stores data.

2.2

Powering On and Main Display

Press the Power key to turn the instrument on. The instrument will beep once, briefly display the splash screen with the YSI logo, then go directly to the main run screen.

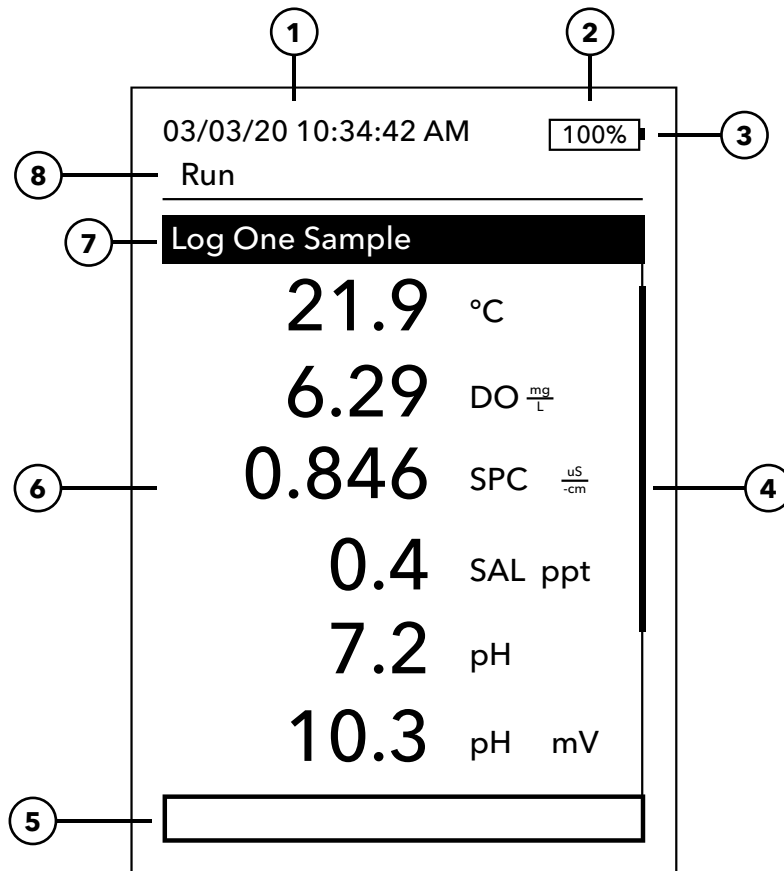

Figure 8 Main display

1	Date/Time
2	Battery life bar
3	USB/PC connection indicator. This is only shown when sending data to a USB flash drive.
4	Scroll bar
5	Message area
6	Displayed measurements
7	Sampling mode indicator Log One Sample is displayed when One Sample Logging is enabled under System → Logging Start Logging... is displayed when Continuous Logging is enabled under System → Logging Stop Logging [00:00:00] is displayed when Continuous Logging is actually running
8	Current screen/menu

i **Contrast** - the contrast adjustment can be accomplished by holding the backlight key (screen will flash) and pressing the left or right arrow keys until the desired contrast is reached.

2.3 Menu Layout

Press the Esc key to escape back to the Run screen. The left arrow can be used to go back to the previous menu in all screens except alpha/numeric entry screens. Functions that are enabled appear as a circle with a dot or a box with a check mark. Disabled functions appear as an empty circle or empty box.

2.4 System Menu

Press the System key to access instrument setup options. These include:

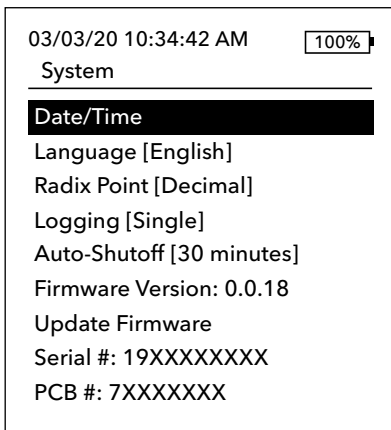

Figure 9 System menu

- Date/Time
- Language
- Radix Point
- Logging
- Auto-Shutoff
- Firmware Version
- Update Firmware
- Serial #
- PCB #

Any item with [brackets] shows the current setting inside the brackets. For instance, in the example screenshot above, Radix Point is currently set to [Decimal]. The brackets provide a quick visual clue as to what items can be changed.

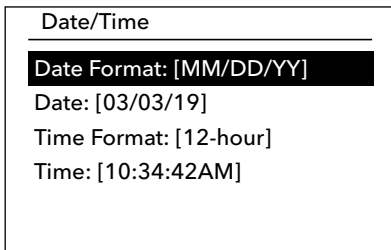

Figure 10 Date/Time

System Menu → Date/Time

Highlight Date/Time from the System menu. Press enter to select.

Date/Time Options

- **Date Format** - Highlight and press enter to open a sub menu for selecting the preferred date format: YY/MM/DD, MM/DD/YY, DD/MM/YY, or YY/DD/MM.
- **Date** - Highlight and press enter to use the numeric entry screen to set the correct date.
- **Time Format** - Highlight and press enter to open a submenu to select the preferred time format from 12-hour or 24-hour.
- **Time** - Highlight and press enter to use the numeric entry screen to set the correct time



Figure 11 Language

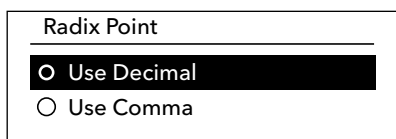

Figure 12 Radix Point

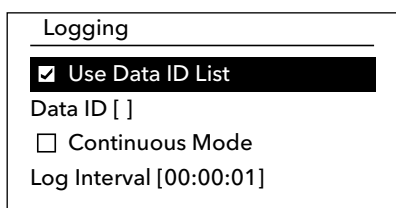

Figure 13 Logging

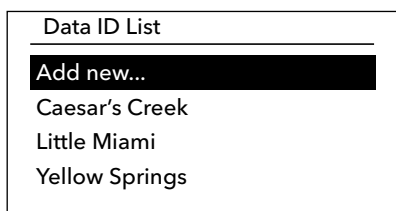

Figure 14 Data ID List

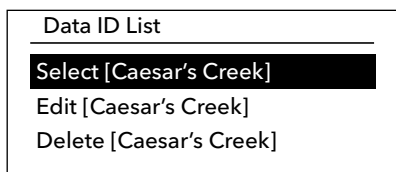

Figure 15 Selecting a Data ID

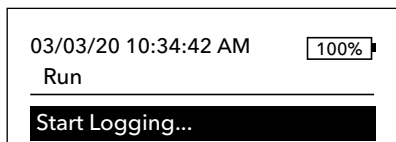

Figure 16 Log Multiple

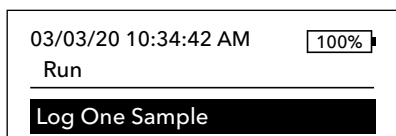

Figure 17 Log One

System Menu → Language

Highlight Language from the System menu. Press enter to select the desired language. Optional languages:

- Chinese (Simplified)
- Chinese (Traditional)
- English
- French
- German
- Italian
- Japanese
- Norwegian
- Portuguese
- Spanish

System Menu → Radix Point

Radix Point allows the user the option to choose between a comma or a decimal in numeric displays. For example, 1.00 becomes 1,00 when **Use Comma** is selected. Highlight **Use Decimal** or **Use Comma** and press enter to select the desired radix.

System Menu → Logging

From the System menu, highlight **Logging** and press enter to view or change the logging options. Logging options include **Use Data ID List** and **Continuous Mode**. A check mark in the box next to these features indicates they are enabled.

Use Data ID List is an optional way of 'tagging' your logged data points. Up to 50 data IDs can be created and stored in the handheld. After selecting **Data ID []**, the Data ID List will be shown. New entries can be created by choosing **Add new...**

Data IDs already created are shown in alphabetical order on the Data ID list. Choose an entry from the Data ID list to **Select**, **Edit**, or **Delete**. When selected, data recorded will be 'tagged' with the Data ID (i.e. the Data ID will be saved as part of the data set).

Continuous Mode (Interval logging): Select the Continuous Mode check box and enter the user-defined Log Interval (in hours:minutes:seconds) to log samples continuously at the specified time interval. The Run screen will display **Start Logging...** when in Continuous Mode. Press ENTER to begin logging. Logging is stopped by pressing ENTER again. The handheld will beep when logging is started and stopped.

One sample logging: Clear the Continuous Mode check box. The Run screen will display Log One Sample. A sample will be logged and the handheld will beep each time the ENTER key is pushed when on the Run screen.



An option to change Data ID (if enabled) appears once ENTER is pressed to begin logging.



System Menu → Auto-Shutoff

Auto Shutoff powers the instrument off after a user specified time period. Highlight **Auto Shutoff** and press enter. Using the alpha/numeric entry screen, enter a value between 0 and 360 minutes. To disable auto shutoff, set the value to 0 (zero).

System Menu → Firmware Version

Firmware Version shows the instrument's firmware version. See Update Firmware section for update instructions.

System Menu → Update Firmware

The current version of instrument firmware can be seen under the System Menu. To update the instrument's firmware:

1. Download the most updated version of firmware from YSI.com.
2. Place the firmware file on a FAT32 formatted USB flash drive. The USB flash drive included with the instrument is FAT32 formatted. **DO NOT** place the firmware file within any folder on the flash drive.
3. Highlight **Update Firmware** and press Enter.
4. Connect the USB flash drive to the instrument using the USB female to micro USB male adapter included with new instruments. The USB symbol () will appear under the battery indicator.
5. Select Yes to begin downloading the firmware. The instrument will upload the file before automatically restarting.
6. Confirm the firmware has downloaded by viewing the Firmware Version under the System Menu.



Updating the firmware will not delete any measurement data, user calibrations, or any settings.

7. The USB flash drive can be disconnected and the firmware download file can now be deleted.

System Menu → Serial

Serial # shows the instrument's serial number. This number should match the number engraved on the back of the instrument's case.

2.5

Sensor Menu



Press the Probe key to access the following options.

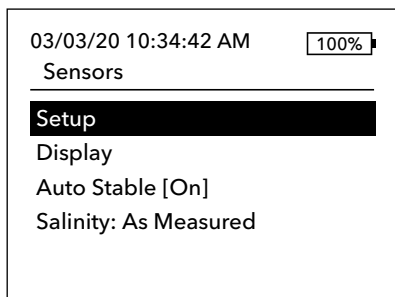

Figure 18 Probe Sensor Menu

- Setup
- Display
- Auto Stable
- Salinity

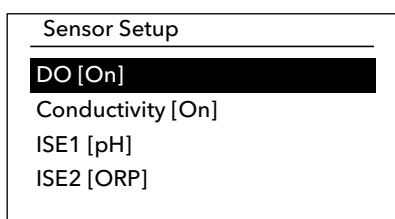

Figure 19 Sensor Setup

Sensor Menu → Sensor Setup

Highlight Setup from the Sensor Menu to configure connected sensors. The following options are available:

- DO
- Conductivity
- ISE1
- ISE2

This list of options essentially corresponds to the sensor port options on a YSI Quatro cable, although any analog Pro Series cable can be used with the instrument – see [Sensor Installation and Cable Connection](#) for more details on compatible sensors and cables.

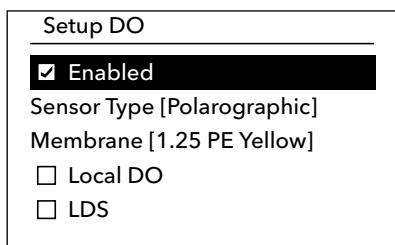

Figure 20 Setup DO

Dissolved Oxygen (DO) Sensor Setup

Under the Sensor Setup menu, highlight **DO** and press Enter.

Enabled allows you to enable or disable the DO channel on the meter. Only enable the DO channel if a DO sensor is actually installed in the cable being used. Highlight Enabled and press Enter to activate (checked box) or deactivate (unchecked box) the DO channel.

Sensor Type sets the type of oxygen sensor being used: either Polarographic (black body) or Galvanic (grey body). Highlight Sensor Type and press enter. Highlight the correct sensor type installed on the cable and press enter to confirm.

If using a ProBOD sensor/cable assembly, the sensor type should be set to polarographic.

Dissolved Oxygen (DO) Sensor Setup (continued)

There are two compatible sensors for use with a field cable:

- Polarographic - This sensor has a black sensor body and is engraved with the model number 2003.
- Galvanic - This sensor has a grey sensor body and is engraved with the model number 2002.

In terms of physical configuration, membrane material, and general performance, YSI Professional Series Galvanic dissolved oxygen sensors are exactly like the Professional Series Polarographic sensors. The advantage of using Galvanic sensors is convenience. Galvanic sensors provide for an instant-on sensor without the need for warm-up time, but this affects the life of the sensor. Polarographic sensors last longer and have a longer warranty, but they require a 5-15 minute warmup time before use or calibration.



IMPORTANT: *The instrument default setting is Galvanic. Please change the Sensor Type to match the correct sensor. If you observe readings very close to 0 or extremely high readings (i.e. 600%), your Sensor Type setting (Polarographic or Galvanic) may be set incorrectly and you should immediately ensure it matches the sensor installed on your cable.*

Membrane sets the type of membrane used on the dissolved oxygen sensor. Highlight Membrane and press enter. Highlight the correct membrane type installed on the sensor and press enter to confirm. The instrument supports the following membrane types:

- 1 mil FEP Fluoropolymer (aka Teflon, Black)
- 1.25 mil PE (Yellow)
- 2.0 mil PE (Blue)

Local DO allows for localized DO% measurements. This sets the calibration value to 100% regardless of the altitude or barometric pressure. Highlight Local DO and press enter to enable (checked box) or disable (empty box) this function. Local DO is a method for the instrument to factor in the barometric pressure on each DO measurement. In essence, if the barometric pressure changes you wouldn't notice the difference in the DO% readings in air-saturated water or water-saturated air. Local DO is ideal for EU compliance. When Local DO is enabled, an L will appear next to DO% on the run screen. DO mg/L readings are unaffected by the selection of DO Local.

LDS (Last Digit Suppression) rounds the DO value to the nearest tenth; i.e. 8.27 mg/L becomes 8.3 mg/L. Highlight LDS and press enter to enable (checked box) or disable (empty box) this function.

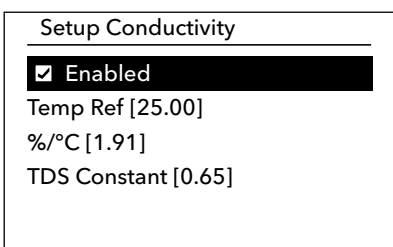

Figure 21 Setup Conductivity

Conductivity Sensor Setup

Under the Sensor Setup menu, highlight **Conductivity** and press Enter.

Enabled allows you to enable or disable the conductivity channel on the meter. Only enable the conductivity channel if a conductivity sensor is actually installed in the cable being used. Highlight Enabled and press Enter to activate (checked box) or deactivate (unchecked box) the conductivity channel.

Temp Ref (Temperature Reference) is the reference temperature used for calculating temperature-compensated Specific Conductance. This will be the temperature all Specific Conductance values are compensated to. The default is 25 °C. To change the Reference Temperature, highlight Temp Ref and press enter. Use the numeric entry screen to enter a new value between 15.00 and 25.00 °C. Next, highlight ENTER at the bottom of the screen and press enter on the keypad to confirm.

Conductivity Sensor Setup (continued)

%/°C (Percent per Degree Celsius) is the temperature coefficient used to calculate temperature compensated Specific Conductance. The default is 1.91% which is based on KCl standards. To change the temperature coefficient, highlight %/°C and press enter. Use the numeric entry screen to enter a new value between 0 and 4%. Next, highlight ENTER at the bottom of the screen and press Enter on the keypad to confirm.

TDS Constant is a multiplier used to calculate an estimated TDS (Total Dissolved Solids) value from conductivity. The multiplier is used to convert Specific Conductance in mS/cm to TDS in g/L. The default value is 0.65. This multiplier is highly dependent on the nature of the ionic species present in the water sample. To be assured of moderate accuracy for the conversion, you must determine a multiplier for the water at your sampling site. Use the following procedure to determine the multiplier for a specific sample:

1. Determine the specific conductance of a water sample from the site.
2. Filter a portion of water from the site.
3. Completely evaporate the water from a carefully measured volume of the filtered sample to yield a dry solid.
4. Accurately weigh the remaining solid.
5. Divide the weight of the solid (in grams) by the volume of water used (in liters) to yield the TDS value in g/L for this site. Divide the TDS value in g/L by the specific conductance of the water in mS/cm to yield the conversion multiplier. Be certain to use correct units.



IMPORTANT: *If the nature of the ionic species at the site changes between sampling studies, the TDS values will be in error. TDS cannot be calculated accurately from specific conductance unless the make-up of the chemical species in the water remains constant.*

To change the multiplier, highlight TDS Constant and press enter. Use the numeric entry screen to enter a new value between 0 and 0.99. Highlight ENTER at the bottom of the screen and press Enter on the keypad to confirm.

ISE Sensor Setup (pH, ORP, Ammonium, Nitrate, Chloride)



WARNING: *Ammonium, Nitrate, and Chloride sensors should only be used at DEPTHS OF LESS THAN 55 FEET (17 METERS). Use of the sensors at greater depths is likely to permanently damage the sensor membrane.*



WARNING: *Ammonium, Nitrate, and Chloride sensors should only be used in FRESHWATER.*

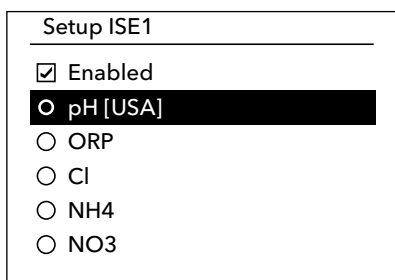

Figure 22 Setup ISE1 or ISE2

Under the Sensor Setup menu, highlight **ISE1** or **ISE2** and press Enter.

Enabled allows you to enable or disable the ISE function and select which ISE sensor is installed on the cable. Highlight Enabled and press Enter to activate (checked box) or deactivate (unchecked box) the ISE channel. Disable the ISE channel(s) if no ISE is installed.



If only using one ISE with the Quatro cable, it must be installed in port 1 (i.e. ISE1). If the Pro Series cable being used only has one port, only enable ISE1.

If enabling pH, the instrument will ask for a buffer set to be identified. The selected option will be displayed in [brackets] next to pH (see screenshot above). **USA** (4, 7, 10) and **NIST** (4.01, 6.86, 9.18) buffer sets are available options. Calibration values are automatically compensated for temperature for USA and NIST buffer sets. **Off** should be selected if not using one of these buffer sets or if you do not want calibration values to be automatically compensated for temperature.

Sensor Setup → Display

The Sensor Display menu determines the parameters and units that are shown on the main display. If more measurements are selected than can be displayed on one screen, a scroll bar will be shown. Use the up and down keys to scroll through the measurements.



Parameters can only be displayed if the corresponding sensor is enabled in Sensor Setup Menu.

Temperature Display

None

°C

°F

K

Figure 23 Temperature Display

DO Display

DO %L

DO mg/L

DO ppm

Figure 24 DO Display

Sp. Conductance Display

Sp. Conductance

Conductivity

Salinity

TDS

Resistivity

Figure 25 Conductivity Display

Temperature Display

To set the units, press the Probe key, highlight **Display** and press enter. Highlight **Temperature** and press enter. Highlight the desired temperature units of **°F**, **°C**, or **K** and press enter to confirm the selection. Only one temperature unit may be displayed at a time. You may also choose not to display temperature. If you choose not to display temperature, other parameters that require a temperature reading will still be temperature compensated.

Dissolved Oxygen (DO) Display

Press the Probe key, highlight **Display** and press enter. Highlight **DO** and press enter. All DO units can be displayed simultaneously. Highlight the unit(s) and press enter to activate (checked box) or deactivate (unchecked box) units from the run screen.

DO % will show DO readings in a percent scale from 0 to 500%.

DO mg/L will show DO readings in milligrams per liter (equivalent to ppm) on a scale from 0 to 50 mg/L.

DO ppm will show DO readings in parts per million (equivalent to mg/L) on a scale from 0 to 50 ppm.

Conductivity Display

Press the Probe key, highlight **Display** and press enter. Highlight **Conductivity** and press enter. Highlight **Sp. Conductance** (Specific Conductance), **Conductivity**, **Salinity**, **TDS**, or **Resistivity**, and press enter to select the reporting units for each parameter. One reporting unit per parameter may be enabled. To disable a parameter, select None. You will not be able to display any of these parameters unless the Conductivity sensor is Enabled in the Sensor Setup Menu first.

Sp. Conductance can be displayed in us/cm or ms/cm. Specific conductance is temperature-compensated conductivity.

Conductivity can be displayed in uS/cm or mS/cm. Conductivity is the measure of a solution's ability to conduct an electrical current. Unlike specific conductance, conductivity is a direct reading without any temperature compensation.

Conductivity Display (continued)

Salinity can be displayed in ppt (parts per thousand) or PSU (practical salinity units). The units are equivalent, as both use the Practical Salinity Scale for calculation.

TDS can be displayed in mg/L (milligrams per liter), g/L (grams per liter), or kg/L (kilograms per liter).

Resistivity can be displayed in ohm-cm (ohms per centimeter), kohm-cm (kilo ohms per centimeter), or Mohm-cm (mega ohms per centimeter).

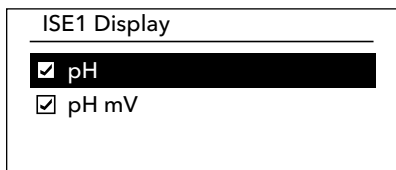

Figure 26 ISE (pH) Display

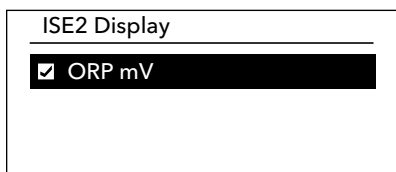

Figure 27 ISE (ORP) Display

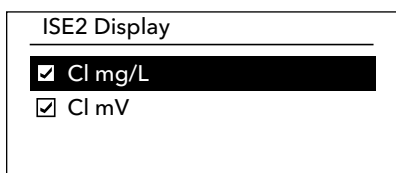

Figure 28 ISE (Chloride) Display

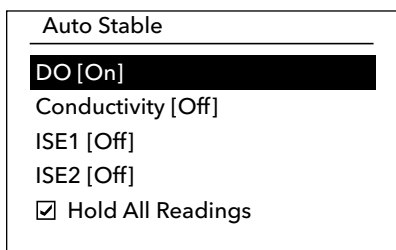

Figure 29 Auto Stable

pH Display

Press the Probe key, highlight **Display** and press enter. Highlight **ISE (pH)** and press enter. You will not be able to Display the sensor unless it is Enabled in the Sensor Setup menu.

Highlight **pH** and/or **pH mV**, press enter to enable (checked box) or disable (unchecked box). Both can be shown at the same time.

ORP Display

Press the Probe key, highlight **Display** and press enter. Highlight **ISE (ORP)** and press enter. You will not be able to Display the sensor unless it is Enabled in the Sensor Setup menu.

Press enter to enable (checked box) or disable (unchecked box) ORP mV.

Ammonium, Ammonia, Nitrate, and Chloride Display

Press the Probe key, highlight **Display**, press enter. Select the appropriate ISE and press enter.

Highlight the value you wish to display and press enter to enable (checked box). Units of **mg/L** and **mV** are available to be displayed for the ammonium, nitrate, and chloride sensors.

If an ammonium sensor is installed, ammonia (NH₃-N) can also be displayed in mg/L. Ammonia is calculated from the pH, salinity, and temperature readings. If a pH sensor is not in use, the instrument will assume the sample is neutral (pH 7) for the calculation. If a conductivity sensor (Salinity) is not in use, the instrument will use the salinity correction value entered in the Sensor Menu for the calculation.

Sensor Setup → Auto Stable

Auto Stable indicates when a reading is stable. To enable Auto Stable, press the Probe key, highlight **Auto Stable**, and press enter. Similar to the Sensor Setup Menu, there are four channel options - **DO**, **Conductivity**, **ISE1**, and **ISE2**. The sensor identified under the Sensor Setup Menu for ISE1 and ISE2 can be seen in parenthesis.

Auto Stable (continued)

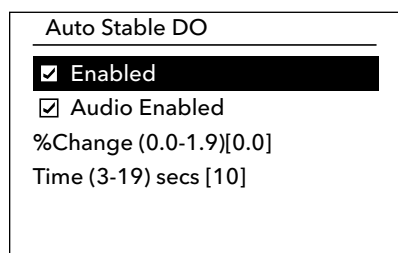

Figure 30 Auto Stable submenu options for DO

Within the Auto Stable menu, you can also choose to **Hold All Readings**. After all sensors have reached their stability criteria, all measurements on the display will be held or 'locked' on the display. If **Hold All Readings** is not enabled, the sensor measurements will continue to change on the display in real time. For example, if DO and pH have **Auto Stable** and **Hold All Readings** enabled, then **all** readings currently on the display (e.g. specific conductance, temperature, ORP in addition to DO and pH) will be 'locked' once DO and pH have both reached their Auto Stable settings. You must press the Esc key to "release" the held display in order to take subsequent readings. **Hold All Readings** must be reactivated after each use!

After selecting one of the channel options, a submenu is displayed with Auto Stable criteria. Highlight **Enabled** and press enter to enable (checked box) or disable (unchecked box). When Auto Stable is enabled, AS will blink next to all enabled parameters for the sensor until the measurement is stable. Once the parameter is stable, AS will stop blinking. If the measurement is stable but a change in the sampling environment causes the stability criteria to no longer be met, AS will blink until stability criteria are met again.

With **Audio Enabled**, the handheld will beep when the measurement is stable.

The user can input a % Change in measurement reading over 'x' amount of Time in seconds. After highlighting **% Change** or **Time (seconds)**, press enter and use the up and down arrow keys to adjust the selected value, then press enter to confirm the change. The % change that can be entered varies based on the channel:

- DO Auto Stable can be set to a % change of 0.0 to 1.9% over 3 to 19 seconds.
- Conductivity Auto Stable can be set to a % change of 0.0 to 1.9% over 3 to 19 seconds.
- ISE Auto Stable can be set to a % change of 0.0 to 9.9% over 3 to 19 seconds.

The Auto Stable criteria will be applied to all units selected to be displayed for the sensor. For example, if pH and pH mV are enabled under the Sensor Display Menu, Auto Stable will be determined for both pH and pH mV.

Once Auto Stable has been configured, press the left arrow key to return to the Auto Stable Menu and configure Auto Stable for other parameters, or press the Esc key to view the main measurement display.

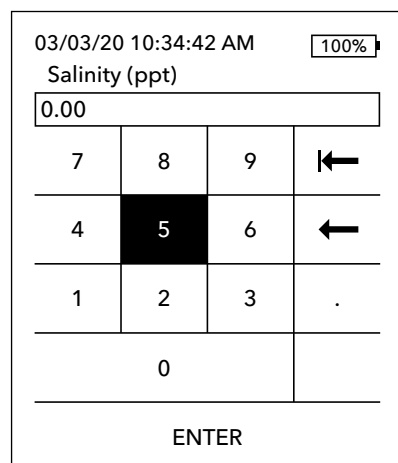

Figure 31 Salinity Value

Sensor Setup → Salinity

The last feature in the Sensor menu is the Salinity correction value which is used to calculate the dissolved oxygen mg/L and ammonia readings when conductivity is not enabled under Sensor Setup.

Press the Probe key, highlight **Salinity**, and press enter. Then, use the numeric entry screen to enter the Salinity value of the water you will be testing from 0 to 70 ppt.

If conductivity has been enabled under Sensor Setup, the salinity measured by the conductivity sensor will be used in the DO and ammonia mg/L calculations and 'As Measured' will be displayed next to Salinity in the Sensor menu.

2.6

Calibration Menu and Procedures

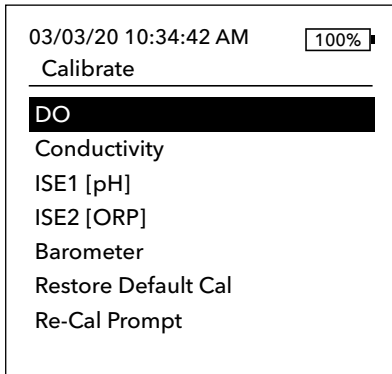

Figure 32 Calibrate Menu

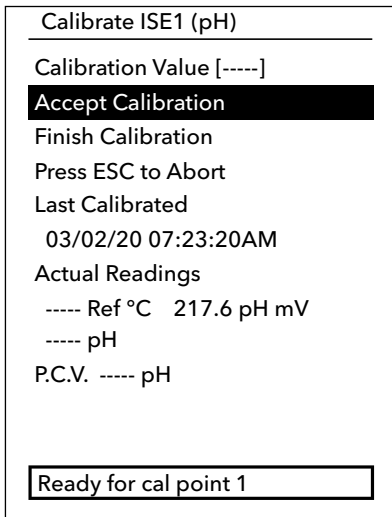

Figure 33 Layout of Calibration screen

Press the Cal key to access the following options. Under the Calibrate Menu, each sensor can be calibrated, default calibration restored, and a recalibration prompt can be configured.

Calibration Screen Layout

The calibration screen has the same basic layout for each parameter.

- **Calibration value:** This is the value the sensor will be calibrated to.
- **Accept Calibration:** Select this to calibrate the sensor to the calibration value.
- **Finish Calibration:** This option is only available with multi-point calibrations (i.e. pH, ammonium, nitrate, and chloride). Finishes the calibration by applying previously accepted points.
- **Press ESC to Abort:** Press the ESC key to leave the calibration. The sensor will not be calibrated to any points. The last successful calibration will be used.
- **Last Calibrated:** The date and time of the last successful sensor calibration for this channel.
- **Actual Readings:** This shows the current measurement value on the Run screen. This is the value that should be observed to ensure the measurement is stable before choosing Accept Calibration.
- **Post Cal Value:** This is the same as the calibration value. This will be the measurement value in the current solution after the calibration is finished. This is shortened to P.C.V. for pH, ammonium, nitrate, and chloride calibrations.

Conductivity Calibration



A 16 oz nalgene bottle is included with all 6051030 ISE/conductivity cables. This bottle can be used to calibrate the conductivity sensor with an ISE sensor installed. A ring-stand should be used to support this container during calibration.

YSI recommends calibrating conductivity first, as the salinity reading from the conductivity sensor is a variable used to determine the dissolved oxygen mg/L measurement. Also, conductivity calibration solutions can easily become contaminated from residual solution from other calibration procedures (e.g. buffer from a pH calibration).

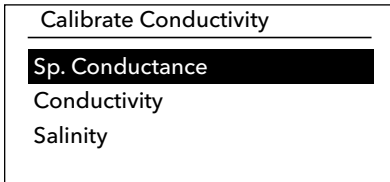

Figure 34 Calibration options for Conductivity

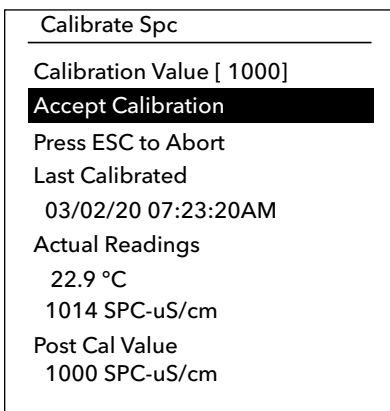

Figure 35 Calibrate specific conductance

Observe the **Actual Readings** for stability (no significant change for 40 seconds), then select **Accept Calibration**. "Calibration successful!" will be displayed in the message area at the bottom of the screen and the handheld will beep before you are returned to the Calibrate Menu.

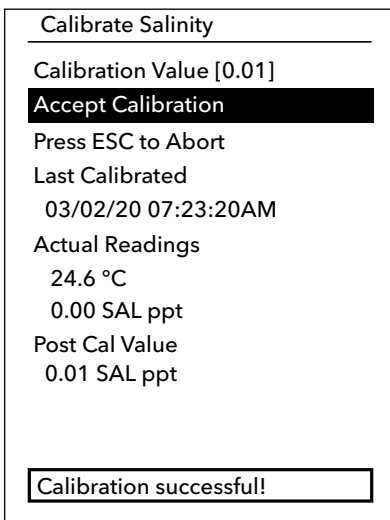

Figure 36 Calibrate Salinity

From the Calibrate Menu, highlight **Conductivity** and press enter.

Highlight the desired calibration method; **Sp. Conductance**, **Conductivity**, or **Salinity** and press enter. YSI recommends calibrating in specific conductance for greatest ease.

It is only necessary to calibrate the conductivity with one method.

Calibrating in Specific (Sp.) Conductance or Conductivity

Place the sensor into a fresh, traceable conductivity calibration solution. The solution must cover the holes of the conductivity sensor that are closest to the cable. Ensure the entire conductivity sensor is submerged in the solution or the instrument will read approximately half the expected value!

Choose the units. If calibrating in specific conductance, choose either **SPC-us/cm** or **SPC-ms/cm**. If calibrating in conductivity, choose either **C-us/cm** or **C-ms/cm**. Press enter after selecting the appropriate units.

Select **Calibration value**, then enter the calibration value of the standard used. Note the measurement units the instrument is reporting and be sure to enter in the correct calibration value for the units being used. For example, 10,000 μ S = 10 mS. Make sure that the units are correct and match the units displayed on the handheld.

Calibrating in Salinity

Place the sensor into a salinity calibration solution. The solution must cover the holes of the conductivity sensor that are closest to the cable. Ensure the entire conductivity sensor is submerged in the solution or the instrument will read approximately half the expected value!

Select **SAL ppt** or **SAL PSU** and press enter.

Select **Calibration value**, then enter the calibration value of the standard used. Observe the **Actual Readings** for stability (no significant change for 40 seconds), then select **Accept Calibration**. "Calibration successful!" will be displayed in the message area at the bottom of the screen before you are returned to the Calibrate Menu.

Dissolved Oxygen Calibration

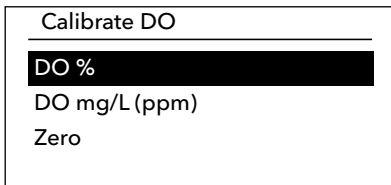

Figure 37 Calibration options for Dissolved Oxygen

The instrument offers three options for calibrating dissolved oxygen: **DO%** in water-saturated air, **DO mg/L (ppm)** in a solution of known dissolved oxygen determined by a Winkler Titration, and a **Zero point**. If performing a zero point calibration, you must also perform a DO% or DO mg/L (ppm) calibration following the zero calibration. For both ease of use and accuracy, YSI recommends performing a 1-point DO% water-saturated air calibration.

i *It is not necessary to calibrate in both % and mg/L (ppm). Calibrating in % will simultaneously calibrate mg/L (ppm) and vice versa.*

DO% Water-Saturated Air Calibration

The supplied sensor storage container (a grey sleeve for a single port cable or a screw on plastic cup for the dual-port and Quatro cables) can be used for DO calibration purposes. The ProBOD probe can be calibrated using a BOD bottle with a small amount of water.

Moisten the sponge in the storage sleeve or plastic cup with a small amount of clean water. The sponge should be clean since bacterial growth may consume oxygen and interfere with the calibration. If using the cup and you no longer have the sponge, place a small amount of clean water (1/8 inch) in the plastic storage cup instead.

Make sure there are no water droplets on the DO membrane or temperature sensor. Then install the storage sleeve or cup over the sensors. The storage sleeve ensures venting to the atmosphere. If using the cup, screw it on the cable and then disengage one or two threads to ensure atmospheric venting. Make sure the DO and temperature sensors are not immersed in water. Turn the instrument on and wait approximately 5 to 15 minutes for the storage container to become completely saturated and to allow the sensors to stabilize.

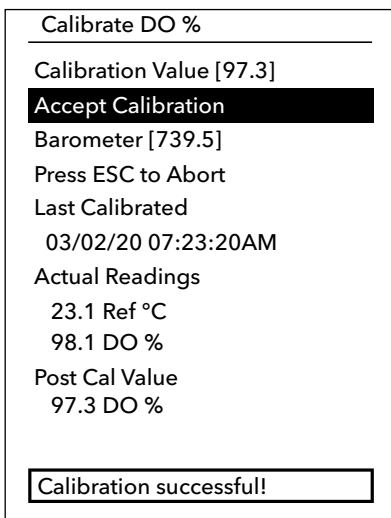

Figure 38 Calibrate DO %

From the Calibrate Menu, highlight **DO** and press enter. Select DO%

The **Calibration value** is automatically determined from the instrument's built-in barometer, so there is no need to modify this value. Highlight Barometer and press enter to adjust it if needed. If the barometer reading is incorrect, it is recommended that you calibrate the barometer.

Observe the **Actual Readings** for stability (no significant change for 40 seconds), then select **Accept Calibration**. "Calibration successful!" will be displayed in the message area at the bottom of the screen and the handheld will beep before you are returned to the Calibrate Menu.

Calibrate DO mg/L	
Calibration Value [7.80]	
Accept Calibration	
Salinity [0.00]	
Press ESC to Abort	
Last Calibrated	
03/02/20 07:23:20AM	
Actual Readings	
23.1 Ref °C	
8.59 DO mg/L	
Post Cal Value	
7.80 DO mg/L	
Calibration successful!	

Figure 39 Calibrate DO mg/L

Calibrate Zero	
Calibration Value [0.0]	
Accept Calibration	
Barometer [733.2]	
Press ESC to Abort	
Last Calibrated	
03/02/20 07:23:20AM	
Actual Readings	
23.3 Ref °C	
-0.3 DO %	
Post Cal Value	0.0 DO %
Calibration successful!	

Figure 40 Calibrate DO Zero Point

DO mg/L (ppm) Calibration

Place the DO sensor into a water sample that has been titrated by the Winkler method to determine the dissolved oxygen concentration in mg/L.

From the Calibrate Menu, highlight **DO** and press enter. Select **DO mg/L**.

Select **Calibration value** and enter the dissolved oxygen concentration of the sample in mg/L.

Observe the **Actual Readings** for stability (no significant change for 40 seconds), then select **Accept Calibration**. "Calibration successful!" will be displayed in the message area at the bottom of the screen and the handheld will beep before you are returned to the Calibrate Menu.

DO Zero Point Calibration

Place the sensor in a solution of zero DO. A zero DO solution can be made by dissolving approximately 8 - 10 grams of sodium sulfite (Na_2SO_3) into 500 mL tap water or DI water. Mix the solution thoroughly. It may take the solution 60 minutes to be oxygen-free.

From the Calibrate Menu, highlight **DO** and press enter. Select **Zero**.

The **Calibration value** is automatically adjusted to 0, so there is no need to modify this value. Observe the **Actual Readings** for stability (no significant change for 40 seconds), then select **Accept Calibration**.

"Calibration successful!" will be displayed in the message area at the bottom of the screen and the handheld will beep before you are returned to the Calibrate Menu.

You must perform a DO% water-saturated air calibration or DO mg/L calibration after performing a zero point calibration.

pH Calibration

Observe the pH mV readings during calibration to understand the condition and response of the pH sensor. In buffer 7, pH mV values should be between -50 and +50. In pH 4 buffer, the mV reading should be 165 to 185 mV higher than the reading in pH 7 buffer. In pH 10 buffer, the mV reading should be 165 to 185 mV lower than the reading in pH 7 buffer. The theoretically ideal slope is -59 mV/pH unit.

1-Point Calibration:

While a 1-point pH calibration is possible, this calibration procedure adjusts only the pH offset and leaves the previously determined slope unaltered. This should only be performed if you are adjusting a previous 2-point or 3-point calibration.

2-Point Calibration:

Perform a 2-point pH calibration if the pH of the media to be monitored is known to be either basic or acidic. In this procedure, the pH sensor is calibrated with a pH 7 buffer and a pH 10 or pH 4 buffer depending upon the pH range you anticipate for your water to be sampled.

3-Point Calibration:

Perform a 3-point pH calibration to assure maximum accuracy when the pH of the environmental water cannot be anticipated or fluctuates above and below pH 7. In this procedure, the pH sensor is calibrated with pH 7, pH 10, and pH 4 buffer solutions.

Additional Calibration Points:

Up to a 6-point calibration can be completed if the buffer set selected under ISE Sensor Setup is set to **Off**. This allows for any combination of buffers to be used, but the Calibration value must be manually adjusted.

pH Calibration Procedure

Please note calibration can be accomplished in any buffer order, but pH 7 (USA buffer set) or 6.86 (NIST buffer set) should always be used regardless of the number of calibration points, as this middle buffer determines the pH offset.

Calibrate ISE1 (pH) <hr/> Calibration Value [4.00] Accept Calibration Finish Calibration Press ESC to Abort Last Calibrated 03/02/20 07:23:20AM Actual Readings 22.6 Ref °C 155.9 pH mV 4.34 pH P.C.V. 4.00 pH <div style="border: 1px solid black; padding: 2px;">Ready for cal point 2</div>

Figure 41 Calibrate pH
(First point)

First Calibration Point

From the Calibrate Menu, highlight **ISE (pH)** and press enter.

The **Calibration value** will automatically be adjusted based on the selected buffer and temperature. Alternatively, the Calibration value can be manually entered.

Observe the **Actual Readings** for stability (no significant change for 40 seconds), then select **Accept Calibration**. "Ready for cal point 2" will be displayed in the message area.

To complete only a 1-point calibration, select **Finish Calibration**. "Calibration successful!" will be displayed in the message area at the bottom of the screen and the handheld will beep before you are returned to the Calibrate Menu.

Calibrate ISE1 (pH)
Calibration Value [7.00]
Accept Calibration
Finish Calibration
Press ESC to Abort
Last Calibrated
03/02/20 07:23:20AM
Actual Readings
22.6 Ref °C 155.9 pH mV
7.34 pH
P.C.V. 7.00 pH
Calibration successful!

Figure 42 Calibrate pH
(Second or third point)

Second Calibration Point

Immerse the probe into the second buffer solution. The **Calibration value** will automatically be adjusted based on the selected buffer and temperature if the selected buffer set is USA or NIST.

Observe the **Actual Readings** for stability (no significant change for 40 seconds), then select **Accept Calibration**. "Ready for cal point 3" will be displayed in the message area.

To complete only a 2-point calibration, select **Finish Calibration**. "Calibration successful!" will be displayed in the message area at the bottom of the screen and the handheld will beep before you are returned to the Calibrate Menu.

Third Calibration Point

Immerse the probe into the third buffer solution. The **Calibration value** will automatically be adjusted based on the selected buffer and temperature if the selected buffer set is USA or NIST.

Observe the **Actual Readings** for stability (no significant change for 40 seconds), then select **Accept Calibration**. "Calibration successful!" will be displayed in the message area at the bottom of the screen and the handheld will beep before you are returned to the Calibrate Menu.

If the buffer set selected is **Off** (see ISE Sensor Setup), the calibration procedure will continue until **Finish Calibration** is selected or the pH sensor has been calibrated to 6 calibration points

ORP Calibration

Obtain a premixed standard solution that is approved for use with Ag/AgCl ORP sensors or prepare a standard with a known oxidation reduction potential (ORP) value. Zobell solution is recommended.

From the Calibrate Menu, highlight **ISE (ORP)** and press enter.

If using YSI Zobell solution, the **Calibration value** will automatically be adjusted based on the temperature. Otherwise, refer to the table included with the standard solution and enter the mV value that corresponds to the temperature of the solution.

Observe the **Actual Readings** for stability (no significant change for 40 seconds), then select **Accept Calibration**. "Calibration successful!" will be displayed in the message area at the bottom of the screen and the handheld will beep before you are returned to the Calibrate Menu.

Calibrate ISE2 (ORP)
Calibration Value [234.5]
Accept Calibration
Press ESC to Abort
Last Calibrated
03/02/20 07:23:20AM
Actual Readings
22.3 Ref °C
225.5 ORP mV
Post Cal Value
234.5 ORP mV
Calibration successful!

Figure 43 Calibrate pH
(Second or third point)

Ammonium, Nitrate, and Chloride Calibration

Exposure to the high ionic content of pH buffers and some conductivity standards can cause a significant, but temporary, drift in the ammonium, nitrate, and chloride ISE sensors. Therefore, when calibrating the pH sensor, YSI recommends that you use one of the following methods to minimize errors in the subsequent readings:

- When calibrating pH, remove ISE sensors from the cable bulkhead and plug the ports. After pH calibration is complete, replace the ISE sensors and proceed with their calibration with no stabilization delay.
- Calibrate pH first, immersing all of the sensors in the pH buffers. After calibrating pH, place the sensors in 100 mg/L nitrate or ammonium standard or 1000 mg/L chloride standard depending on the sensor in use and monitor the reading. Usually, the reading starts low and may take a while to reach a stable value. When it does, proceed with the calibration. This may take several hours.

YSI recommends a 2-point calibration for ISEs. For the best results, use the standards that differ by 2 orders of magnitude. Examples include:

- 1 mg/L and 100 mg/L for Ammonium and Nitrate
- 10 mg/L and 1,000 mg/L for Chloride

1-Point and 2-Point ISE Calibration Procedure

From the Calibrate Menu, highlight the appropriate ISE and press enter.

Select **Calibration value** and enter the value that corresponds to the first calibration standard.

Observe the **Actual Readings** for stability (no significant change for 40 seconds), then select **Accept Calibration**. "Ready for cal point 2" will be displayed in the message area.

To complete only a 1-point calibration, select **Finish Calibration**. "Calibration successful!" will be displayed in the message area at the bottom of the screen and the handheld will beep before you are returned to the Calibrate Menu.



Finish Calibration is not visible until the sensor has been calibrated to the first point (i.e. Accept Calibration has been selected once to complete calibration to the first point).

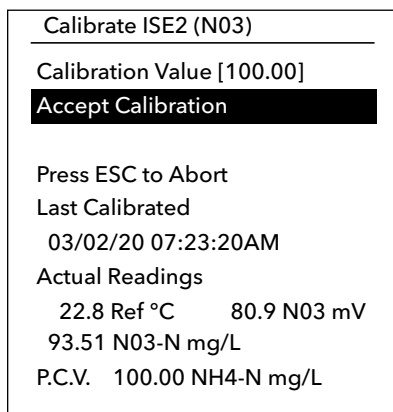

Figure 44 Calibrate Nitrate

Select **Calibration value** and enter the value of the second calibration standard. Observe the **Actual Readings** for stability (no significant change for 40 seconds), then select **Accept Calibration**. "Ready for cal point 3" will be displayed in the message area. To complete only a 2-point calibration, select **Finish Calibration** (instrument will beep after "Calibration successful!" is displayed). Otherwise, continue with the chilled third calibration point procedure below.

Chilled Third Calibration Point

The chilled 3-point calibration is recommended if there is a large temperature variation during sampling or when the temperature of the media cannot be anticipated. The highest concentration solution and one of the lower concentration solutions should be at ambient temperature. The other lower concentration solution should be chilled to less than 10°C to prior calibration point.

Discard the used standard for the second point and rinse the probe and calibration cup with a small amount of the chilled third calibration point standard. Discard the rinse standard.

Fill the calibration cup to the appropriate level with fresh standard for the third calibration point. Immerse the probe in the standard.

Select **Calibration value** and enter the value of the third calibration standard. Observe the **Actual Readings** for stability (no significant change for 40 seconds), then select **Accept Calibration**. "Calibration successful!" will be displayed in the message area and the handheld will beep before you are returned to the Calibrate Menu.

Calibrate Barometer
Calibration Value [733.2]
Accept Calibration
Press ESC to Abort
Last Calibrated
03/02/20 07:23:20AM
Actual Readings
26.2 Ref °C
733.2 mmHg
Post Cal Value
733.2 mmHg

Figure 45 Calibrate Barometer

Barometer Calibration

The barometer is factory calibrated and should rarely need to be recalibrated. The barometer is used for DO% calibration and DO% measurements. Verify that the barometer is accurately reading "true" barometric pressure and recalibrate as necessary.

From the Calibrate Menu, highlight **Barometer** and press enter.

Select **Calibration value** and enter the correct "true" barometric pressure.

Observe the **Actual Readings** for stability (no significant change for 40 seconds), then select **Accept Calibration**. "Calibration successful!" will be displayed in the message area at the bottom of the screen and the handheld will beep before you are returned to the Calibrate Menu.



Laboratory barometer readings are usually "true" (uncorrected) values of air pressure that can be used "as is" for barometer calibration. Weather service readings are usually not "true" (i.e. they are corrected to sea level) and therefore cannot be used until they are "uncorrected." An approximate formula for this "uncorrection" is below:

$$\text{True BP} = [\text{Corrected BP}] - [2.5 * (\text{Local Altitude in ft. above sea level}/100)]$$

Restore Default Calibration Values

Occasionally, the instrument may need to have the factory calibration default values restored.

From the Calibrate Menu, highlight **Restore Default Cal** and press enter. Highlight the channel you wish to restore to default and press enter. Next you will be asked to confirm the operation. Highlight Yes and press enter to confirm. The handheld will beep after the default calibration is restored.

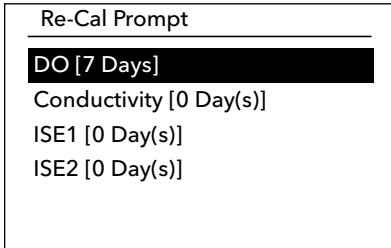

Figure 46 Re-Cal Prompts

Recalibration Prompt

The recalibration prompt can be used to remind the user to perform a calibration.

From the Calibrate Menu, highlight **Re-Cal Prompt** and press enter. Highlight the sensor you wish to be reminded about and press enter to access the numeric entry screen.

Enter a value in days and press enter to confirm the reminder time. To turn off the Re-cal prompt, set the reminder to zero (0) days (this is the default).

The instrument will check for an expired Re-Cal Prompt each time it is turned on. If a sensor calibration has not occurred within the user-defined number of days, the instrument will display a short message reminding the user to calibrate the specified channels.

2.7

Files Menu

Press the File key to access the Files Menu. Use the Files menu to view and delete data. Data can be filtered by a specific date and time range and by user-created Data IDs

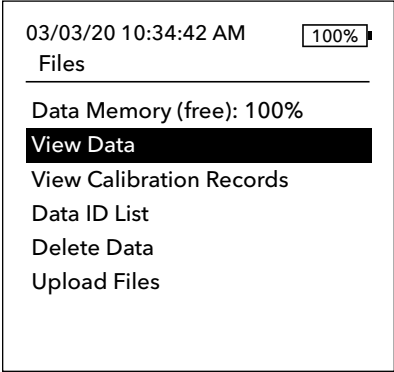

Figure 47 Files Menu

Data Memory

The Data Memory shows a percentage indicating the amount of memory available. If the file memory is near 0%, files should be backed up to a USB flash drive and/or deleted to free up memory.

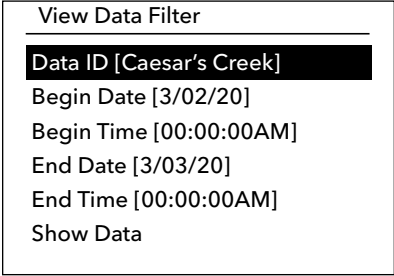

Figure 48 View Data Filter

Viewing Saved Data

From the Files Menu, highlight **View Data** and press enter. Enter the desired filter criteria, then select **Show Data** to view data in a table. If necessary, use the arrow keys to scroll through the data.

Data ID: View data from one ID or all IDs.

Begin/End: View data within specific date and time ranges.

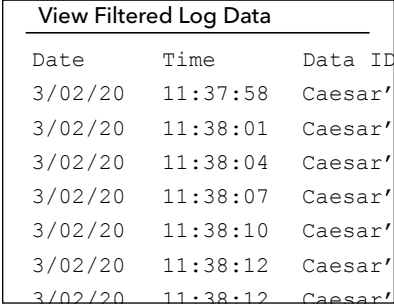

Date	Time	Data ID
3/02/20	11:37:58	Caesar'
3/02/20	11:38:01	Caesar'
3/02/20	11:38:04	Caesar'
3/02/20	11:38:07	Caesar'
3/02/20	11:38:10	Caesar'
3/02/20	11:38:12	Caesar'
3/02/20	11:38:12	Caesar'

Figure 49 View Filtered Log Data



View Calibration Records

From the Files Menu, highlight **View Calibration Records** and press enter. Select the channel from which you'd like to view the 10 most recent calibration records. Options include: DO, Conductivity, ISE1, ISE2, and Barometer. Use the arrow keys to scroll through the records.

Calibration record content varies based on the sensor type.

View Cal. Records
Conductivity [10 of 10]
Date: 03/03/20
Time: 07:18:35AM]
Method: Salinity
Cal Value:
45.38 SAL ppt
Sensor V.:
45.38 SAL ppt
Temp. Ref.: 25.0 °C
Temp. Coeff.: 0.0191 %/°C
TDS Constant: 0.65

Figure 50 View Calibration Records

Conductivity Sensor Calibration Record Content

- Date and Time
- Method (Spec Cond, Cond, Salinity)
- Cal Value (value of calibration solution)
- Sensor Value
- Temperature Reference (User selected in Sensor Setup menu)
- Temperature Compensation Coefficient %/°C (User selected in Sensor Setup menu)
- TDS Constant (User selected in Sensor Setup menu)
- Temperature
- Cal Cell Constant
- Calibrate Status

DO Sensor Calibration Record Content

- Date and Time
- Method (% , mg/L)
- Cal Value
- Sensor Value (Sensor Current)
- Sensor Type (Polarographic/Galvanic)
- Membrane Type (Teflon Black, PE Yellow, PE Blue)
- Salinity Mode (user entered value if in Manual Salinity Mode)
- Temperature
- Barometer
- Calibrate Status

pH Sensor Calibration Record Content - Up to 6 Calibration Points

- Date and Time
- Buffer Value
- Sensor Value (mV)
- Temperature
- Slope (mV/pH)
- Slope (% of ideal)
- Calibrate Status



ORP Sensor Calibration Record Content

- Date and Time
- Cal Solution Value
- Sensor Value
- Temperature
- Calibrate Status

Ammonium, Nitrate, and Chloride Sensor Calibration Record Content - Up to 3 Calibration Points

- Date and Time
- Buffer Value
- Sensor Value (mV)
- Temperature
- Calibrate Status

Barometer Calibration Record Content

- Date and Time
- Cal Value
- Calibrate Status

View Cal. Records

Conductivity [10 of 10]
 Date: 03/03/20
 Time: 07:18:35AM]
 Method: Salinity
 Cal Value:
 45.38 SAL ppt
 Sensor V.:
 45.38 SAL ppt
 Temp. Ref.: 25.0 °C
 Temp. Coeff.: 0.0191 %/°C
 TDS Constant: 0.65

Figure 51 View Calibration Records

View Data ID List



"Use Data ID List" must be enabled in System → Logging for data to be tagged with a Data ID.

From the Files Menu, highlight **Data ID List** and press enter. The Data ID List can also be viewed and managed under System → Logging.

Data ID List

Add new...

Caesar's Creek

Little Miami

Yellow Springs

Figure 52 Data ID List

New entries can be created by choosing **Add new...**

Data IDs already created are shown in alphabetical order on the Data ID list. Choose an entry from the Data ID list to Select, Edit, or Delete. When selected, data recorded will be 'tagged' with the Data ID (i.e. the Data ID will be saved as part of the data set).

Data ID List

Select [Caesar's Creek]

Edit [Caesar's Creek]

Delete [Caesar's Creek]

Figure 53 Selecting a Data ID

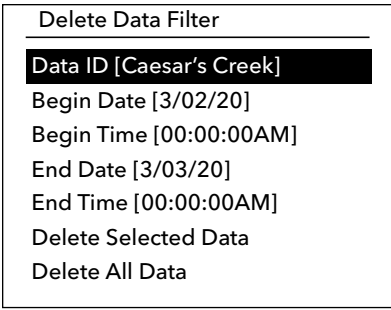

Figure 54 Delete Data Filter

Delete Data

From the Files Menu, highlight **Delete Data** and press enter.

Enter the desired filter criteria, then select **Delete Selected Data** to permanently delete the data. Select **Delete All Data** to permanently delete all logged data from the handheld.

The handheld will beep to confirm data has been successfully deleted.

Upload Files

Data logged to the instrument and user calibration records can be sent to a USB flash drive as CSV files. A USB female to micro USB male adapter is included with new instruments for this data backup. Please note the USB storage device must be formatted as FAT32, not NTFS or exFAT. The handheld will only support FAT32. The USB flash drive included with the instrument can be used for this data backup.

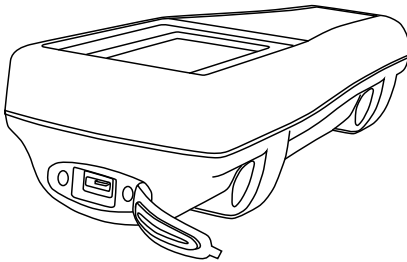



Figure 55 Micro USB female connector

After connecting a flash drive to the instrument via the adapter cable and the USB symbol () has appeared under the battery indicator, highlight Upload Files and press Enter. Once "Upload Successful" is displayed in the message area, the instrument will beep and the user will be returned to the Files Menu. If the download is not successful, ensure the USB connection indicator can be seen at the top of the display when data is being transmitted.

Once downloaded, there are two CSV files that can be copied to a location on your PC:

- ProQ_Logdata.csv
 - o This record contains all of the data currently stored on the handheld.
- ProQ_Calhis.csv
 - o This record contains the last 10 calibration records for each channel (DO, Conductivity, ISE1, and ISE) and the barometer.

Please note these files will be overwritten on the flash drive each time **Download Files** is selected.

Once the CSV files are on your PC, they can easily be opened in Excel. When opening either CSV file, most users should not have to use Excel Text Import Wizard for the data to appear correctly, as the CSV files have a line of text at the top of the file (sep=;) that directs Excel to use a semi-colon as the delimiter.

2.8 Taking Measurements

For the highest accuracy, calibrate the sensor(s) before taking measurements. Some recommendations when preparing to record data are:

1. Under Probe → Setup, configure the DO, Conductivity, and ISE channels for the sensors that will actually be connected to the instrument.
2. Under Probe → Display, configure the parameters that will be displayed on the Run screen
 - a. Along with Date/Time and Data ID (see #4 below), all parameters enabled under Probe → Display will be part of the data record. Any parameters not enabled to be displayed will not be part of the data record.
3. Create Data IDs for logged data (if applicable). This will be added to the data record.
4. Set the logging method (single or interval/continuous).
5. Set the Auto Stable parameters (if applicable).
6. On the main run screen, press ENTER to begin logging (single or interval/continuous). See System Menu → Logging for more information.
 - a. An option to change the Data ID (if enabled) appears once ENTER is pressed to begin logging.
7. To stop continuous logging, simply press the ENTER key again.

2.9 Instrument Display Range

The ProQuatro will display values from -99999 to 199999 for all parameters/units. It will display “+++++” and “-----” when outside of this range. Please note that only readings within the range identified on the instrument’s specification sheet will meet the stated accuracy specification.

If the readings on the display are unrealistic (i.e. obviously incorrect), please ensure the sensors connected to the instrument are correctly identified in the Sensor Setup menu. If the sensor is correctly identified in this menu, conduct the recommended sensor cleaning and attempt to calibrate the sensor. If this does not work, contact YSI Technical Support to help determine the next step.

3. Care, Maintenance, and Storage

This section describes the proper procedures for care, maintenance and storage of the sensors. The goal is to maximize their lifetime and minimize down-time associated with improper sensor usage.

3.1 General Maintenance

O-Rings

The instrument utilizes o-rings as seals to prevent water from entering the battery compartment and sensor ports. Following the recommended procedures will help keep your instrument functioning properly. If the o-rings and sealing surfaces are not maintained properly, it is possible that water can enter the battery compartment and/or sensor ports of the instrument. If water enters these areas, it can severely damage the battery terminals or sensor ports causing loss of battery power, false readings, and corrosion to the sensors or battery terminals. Therefore, when the battery compartment lid is removed, the o-ring that provides the seal should be carefully inspected for contamination (e.g. debris, grit, etc.) and cleaned if necessary.

The same inspection should be made of the o-rings associated with the sensor connectors when they are removed. If no dirt or damage to the o-rings is evident, then they should be lightly greased without removal from their groove. However, if there is any indication of damage, the o-ring should be replaced with an identical o-ring. At the time of o-ring replacement, the entire o-ring assembly should be cleaned.

To remove the o-rings:

Use a small, flat-bladed screwdriver or similar blunt-tipped tool to carefully remove the o-ring from its groove. Check the o-ring and the groove for any excess grease or contamination. If contamination is evident, clean the o-ring and nearby plastic parts with lens cleaning tissue or equivalent lint-free cloth. Alcohol can be used to clean the plastic parts, but use only water and mild detergent on the o-ring itself. Also, inspect the o-rings for nicks and imperfections.



Using alcohol on o-rings may cause a loss of elasticity and may promote cracking. Do not use a sharp object to remove the o-rings. Damage to the o-ring or the groove may result.

Before re-installing the o-rings, make sure to use a clean workspace, clean hands, and avoid contact with anything that may leave fibers on the o-ring or grooves. Even a very small amount of contamination (hair, grit, etc.) may cause a leak.

To re-install the o-rings:

Place a small amount of o-ring grease between your thumb and index finger. More grease is NOT BETTER!

Draw the o-ring through the grease while pressing the fingers together to place a very light covering of grease to the o-ring. Place the o-ring into its groove making sure that it does not twist or roll.

Use your grease-coated finger to once again lightly go over the mating surface of the o-ring.



Do not over-grease the o-rings. The excess grease may collect grit particles that can compromise the seal. Excess grease can also cause the waterproofing capabilities of the o-ring to diminish, potentially causing leaks. If excess grease is present, remove it using a lens cloth or lint-free cloth.

Sensor Ports

It is important that the entire sensor connector end be dry when installing, removing or replacing. This will prevent water from entering the port. Once a sensor is removed, examine the connector inside the port. If any moisture is present, use compressed air to completely dry the connector or place directly in front of a steady flow of fresh air. If the connector is corroded, return the cable to your dealer or directly to a YSI Repair Center.



Remove sensors upside down (facing the ground) to help prevent water from entering the port upon removal

3.2 Sensor Maintenance

Dissolved Oxygen Sensor Maintenance

Membrane Cap Installation

The DO sensor (Polarographic and Galvanic) is shipped with a dry, protective red cap that will need to be removed before using. Remove the protective cap or used membrane cap and replace it with a new membrane cap following these instructions:

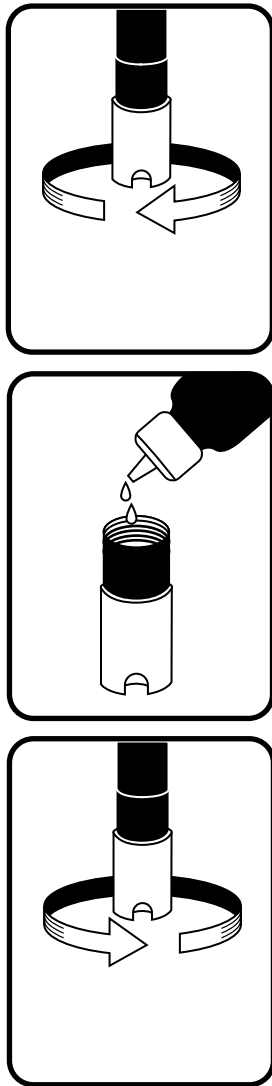

Figure 56 Installing the membrane cap

1. Remove the sensor guard to access the sensor tip.
2. Unscrew and remove any old membrane cap by holding the sensor when unscrewing the membrane cap and discard.
3. Thoroughly rinse the sensor tip with distilled or DI water.
4. Fill a new membrane cap with O₂ sensor electrolyte solution that has been prepared according to the directions on the bottle. Be very careful not to touch the membrane surface. Lightly tap the side of the membrane cap to release bubbles that may be trapped.
5. Thread the membrane cap onto the sensor. It is normal for a small amount of electrolyte to overflow.

Polarographic Sensors

The KCl (potassium chloride) solution and the membrane cap should be changed at least once every 30 days during regular use. In addition, the KCl solution and membrane should be changed if (a) bubbles are visible under the membrane; (b) significant deposits of dried electrolyte are visible on the membrane; and (c) if the sensor shows unstable readings or other sensor-related symptoms.

During membrane changes, examine the gold cathode at the tip of the sensor and the silver anode along the shaft of the sensor. If either the silver anode is black in color or the gold cathode is dull, the sensor may need resurfaced using the fine sanding disks included in the membrane kit. Do not sand the electrode every membrane change as this is not routine maintenance. In fact, visually, the anode may appear tarnished and operate just fine. YSI recommends using the 400 grit wet/dry sanding disks to resurface the electrodes if the sensor has difficulty stabilizing or calibrating after a membrane change.

To resurface the sensor using the fine sanding disk, follow the instructions below.

Gold Cathode:

For correct sensor operation, the gold cathode must be textured properly. It can become tarnished or plated with silver after extended use. Never use chemicals or abrasives not recommended or supplied by YSI.

First dry the sensor tip completely with lens cleaning tissue. Wet a sanding disk with a small amount of clean water and place it face up in the palm of your hand.

Polarographic Sensors (*continued*)

Next, with your free hand, hold the sensor in a vertical position, tip down. Place the sensor tip directly down on the sanding disk and twist it in a circular motion to sand the gold cathode. The goal is to sand off any build-up and to lightly scratch the cathode to provide a larger surface area for the O₂ solution under the membrane. Usually, 3 to 4 twists of the sanding disk are sufficient to remove deposits and for the gold to appear to have a matte finish. Rinse thoroughly and wipe the gold cathode with a wet paper towel before putting on a new membrane cap. If the cathode remains tarnished, contact YSI Technical Support or the Authorized dealer where you purchased the instrument.

Silver Anode:

After extended use, a thick layer of Silver Chloride (AgCl) builds up on the silver anode reducing the sensitivity of the sensor. The anode must be cleaned to remove this layer and restore proper performance. The cleaning can be chemical or mechanical:

Chemical cleaning: Remove the membrane cap and rinse the electrodes with deionized or distilled water. Soak the sensing anode section of the sensor in a 14% ammonium hydroxide solution for 2 to 3 minutes or in a 3% ammonia solution overnight for 8-12 hours (most household ammonia cleaners are typically around 3%). Rinse heavily in cool tap water followed by a thorough rinsing with distilled or deionized water. The anode should then be thoroughly wiped with a wet paper towel to remove the residual layer from the anode. You can smell the tip of the sensor to help ensure all the ammonia has been rinsed off. Trapping residual ammonia under the new membrane cap can quickly tarnish the electrode and/or give false readings.



Chemical cleaning should be performed as infrequently as possible. First attempt a membrane change and recalibrate. If a new membrane does not resolve the problem, then proceed with cleaning.

Mechanical cleaning: In order to sand the silver anode along the shaft of the sensor, simply hold the sensor in a vertical position. Wet the sanding disk with a small amount of clean water, then gently wrap it around the sensor shaft and twist it a few times to lightly sand the anode (the goal is to simply sand off any build-up without scratching or removing layers of the anode itself). Usually, 3 to 4 twists of the sanding disk are sufficient to remove deposits. However, in extreme cases, more sanding may be required to regenerate the original silver surface.

After completing the sanding procedure, repeatedly rinse the electrode with clean water and wipe with lens cleaning tissue to remove any grit left by the sanding disk. Thoroughly rinse the entire tip of the sensor with distilled or deionized water and install a new membrane.



IMPORTANT: *Be sure to: (1) Use only the fine sanding disks provided and (2) Sand as mentioned in the above procedures. Not adhering to either of these instructions can damage the electrodes. If this procedure is unsuccessful, as indicated by improper electrode performance, contact YSI Technical Support or the Authorized dealer where you purchased the instrument.*

Galvanic Sensors

We recommend that the Sodium Chloride (NaCl) solution and the membrane cap be changed at least once every 60 days during regular use. In addition, the NaCl solution and membrane should be changed if (a) bubbles are visible under the membrane; (b) significant deposits of dried electrolyte are visible around the membrane; and (c) if the sensor shows unstable readings or other sensor-related symptoms.

The Galvanic dissolved oxygen sensor is continuously reducing oxygen even when the display of the instrument is not active. This factor allows the sensor to be used with no warm-up period as soon as the instrument is powered on (instant on DO). However, because the sensor is "on" all the time, some solid from the oxidation of the zinc anode will form in the electrolyte within 1-2 weeks of activation. Small amounts of the solid will generally cause no performance problems, but excessive amounts may result in jumpy dissolved oxygen readings. The rate of solid formation is dependent on the type of membrane installed. The formation of solids based on membrane type typically form more rapidly with the 5912 (1 mil Teflon), less rapid with 5913 (1.25 mil PE), and least rapid with 5914 (2 mil PE).



The Galvanic DO sensor solution will appear milky white after use but will NOT affect the accuracy of the sensor unless there is excessive build up. The color change is acceptable and normal as long as DO readings remain stable.

At the time the membrane cap is changed, YSI recommends that you rinse the anode (silver shaft of the sensor) with purified water and wipe with a clean paper towel. If white deposits are evident on the anode after cleaning, YSI recommends that you remove this material by sanding the anode with the sandpaper disk enclosed in your membrane kit. Follow the "Mechanical Cleaning" instructions under the Polarographic Silver Anode section.



IMPORTANT: *Be sure to: (1) Use only the fine sanding disks provided and (2) Sand as mentioned in the above procedures. Not adhering to either of these instructions can damage the electrodes.*



WARNING: *DO NOT PERFORM THE POLAROGRAPHIC CHEMICAL CLEANING ON A GALVANIC SENSOR. If this procedure is unsuccessful, as indicated by improper electrode performance, contact YSI Technical Support or the Authorized dealer where you purchased the instrument*

Conductivity Sensor Maintenance

The openings that allow sample access to the conductivity electrodes should be cleaned regularly. The small cleaning brush included in the Maintenance Kit is ideal for this purpose. Dip the brush in clean water and insert it into each hole 10 to 12 times. In the event that deposits have formed on the electrodes, it may be necessary to use a mild detergent (laboratory grade soap or bathroom foaming tile cleaner) with the brush. Rinse thoroughly with clean water, then check the response and accuracy of the conductivity cell with a calibration standard.



If this procedure is unsuccessful, as indicated by improper electrode performance, contact YSI Technical Support or the Authorized dealer where you purchased the instrument.

Temperature Sensor Maintenance

You must keep the temperature portion of the sensor free of buildup. Other than that, the sensor requires no maintenance. The conductivity cleaning brush can be used to scrub the temperature sensor if needed. Alternatively, you can use a toothbrush to clean the sensor.

pH, ORP, and pH/ORP Sensor Maintenance



Typical working life for pH and ORP sensors is approximately 12-24 months depending on usage, storage, and maintenance. Proper storage and maintenance generally extends the sensor's working life.

Chemical cleaning is required whenever deposits or contaminants appear on the glass and/or platinum surfaces or when the sensor's response slows. Removing the sensor from the cable may make cleaning easier.



CAUTION: *It is not recommended to perform any mechanical cleaning (e.g. scrubbing), as this can permanently damage the glass bulb.*

To chemically clean the sensor:

1. Soak the sensor for 10-15 minutes in clean water containing a few drops of commercial dishwashing liquid.
2. Rinse the sensor in clean water.

If good pH and/or ORP response is still not restored, perform the following additional procedure:

1. Soak the sensor for 30-60 minutes in one molar (1 M) hydrochloric acid (HCl). This reagent can be purchased from most lab supply distributors. Be sure to follow the safety instructions included with the acid.
2. Rinse the sensor in clean water.

pH, ORP, and pH/ORP Sensor Maintenance (*continued*)

If biological contamination of the reference junction is suspected or if good response is not restored by the above procedures, perform the following additional cleaning step:

1. Soak the sensor for approximately 1 hour in a 1:1 dilution of commercially-available chlorine bleach.
2. Rinse the sensor in clean water and then soak for at least 1 hour in clean water with occasional stirring to remove residual bleach from the junction. (If possible, soak the sensor for a period of time longer than 1 hour in order to be certain that all traces of chlorine bleach are removed.) Then re-rinse the sensor with clean water and retest.

 *Dry the port and sensor connector with compressed air and apply a very thin coat of o-ring lubricant to all o-rings before reinstallation*

Chloride Sensor Maintenance

 *Typical working life for chloride sensors is approximately 3-6 months depending on usage, storage, and maintenance. Proper storage and maintenance generally extends the sensor's working life.*

The chloride sensor is considered a pellet membrane ISE. As always, when handling sensors, care should be taken to avoid damaging the membrane. This sensor can be regenerated by washing with alcohol and/or gently polishing with fine emery paper in a circular motion to remove any deposits or discoloration, then thoroughly washing with deionized water to remove any debris. The sensor may require soaking in the high standard chloride calibration solution to recover its performance.

Ammonium and Nitrate Sensor Maintenance

 *Typical working life for ammonium and nitrate sensors is approximately 3-6 months depending on usage, storage and maintenance. Proper storage and maintenance generally extends the sensor's working life.*

The ammonium and nitrate sensors are PVC membranes. As always, when handling a sensor, care should be taken to avoid damaging the membrane. After extensive use the membranes may become coated with a deposit or scoured with fine scratches which may cause a slow or reduced response (low slope) or unstable readings. Deposits may be removed with a fine jet of deionized water or rinsing in alcohol followed by soaking in the high standard calibration solution. Gently dab dry with a lint-free tissue before taking measurements.

3.3

Sensor Storage

Short-Term Storage - All Sensors

The cable assembly is supplied with a sensor storage container, or sleeve, that attaches to the cable. The container is used for short-term storage (less than 30 days). Be sure to keep a small amount of moisture (tap water) in the container during storage. This is done to maintain a 100% saturated air environment which is ideal for short-term sensor storage. The sensors should not be submerged in water. The intent is to create a humid air storage environment.

Temperature Sensor Long-term Storage

No special storage is required. The temperature sensor can be stored dry or wet as long as solutions in contact with the thermistor are not corrosive (for example, chlorine bleach). The storage temperature should be -5 to 70 °C (23 to 158 °F).

Conductivity Sensor Long-term Storage

No special storage is required. Sensors can be stored dry or wet as long as solutions in contact with conductivity electrodes are not corrosive (for example, chlorine bleach). However, it is recommended that the sensor be cleaned with the provided brush prior to and after long term storage. The storage temperature should be -5 to 70 °C (23 to 158 °F).

Dissolved Oxygen Sensor Long-term Storage

Dissolved oxygen sensors (Polarographic and Galvanic) should be stored in a dry state for long term storage. First, remove the membrane cap and thoroughly rinse the sensor with clean water. Next, either blow it dry with compressed air or allow to air dry completely. Install a clean, dry new membrane cap over the sensor to keep it dry and to protect the electrodes. with compressed air or allow to air dry completely. Install a clean, dry new membrane cap over the sensor to keep it dry and to protect the electrodes.

After storing the sensor for a long period of time, it is necessary to "condition" the sensor by putting a new membrane with electrolyte solution on the sensor and then turning the instrument on to allow the sensor sufficient time to stabilize.

The storage temperature should be -5 to 70 °C (23 to 158 °F).

pH Sensor Long-term Storage

The key to pH sensor storage, short or long-term, is to make certain that the sensor does not dry out. Sensors which have been allowed to dry out due to improper storage procedures may be irreparably damaged by the dehydration and will require replacement. You can try to rehydrate the sensor by soaking it (preferably overnight) in a potassium chloride solution or a pH 4 buffer before attempting to calibrate.

To store the sensor, remove it from the cable and seal the vacant port with a port plug. Fill the original shipping/storage vessel (plastic boot or bottle) with buffer 4 solution and then submerge the sensor into the solution. The sensor should remain submerged in the solution during the storage period; therefore, make certain that the vessel is sealed to prevent evaporation and periodically check the vessel to ensure the sensor does not dry out.

The storage temperature should be 0 to 30 °C (32 to 86 °F).



It is important not to store the pH sensor in distilled or deionized water, as the glass sensor may be damaged by exposure to this medium.

ORP Sensor Long-term Storage

To store, remove the sensor from the cable and seal the vacant port with the provided plug. Fill the original shipping/storage vessel (plastic boot or bottle) with buffer 4 solution and then submerge the sensor into the solution. The sensor should remain submerged in the solution during the storage period; therefore, make certain that the vessel is sealed to prevent evaporation and periodically check the vessel to ensure the sensor does not dry out. The storage temperature should be 0 to 30 °C (32 to 86 °F).

Ammonium, Nitrate, and Chloride Sensor Long-term Storage

The key to ISE sensor storage, short or long-term, is to make certain that the sensor does not dry out. Sensor junctions that have been allowed to dry out due to improper storage procedures may be irreparably damaged by the dehydration and will require replacement. You can attempt to rehydrate the sensor by soaking it (preferably overnight) in the sensor's high calibration solution before attempting to calibrate.

The recommended storage of these sensors is in moist air. Remove the sensor from the cable and seal the vacant port with the provided plug. Place the sensor in its original shipping storage vessel (plastic boot or bottle) with a small amount of tap water or its high calibration standard. The vessel should remain a saturated air environment. The sensor only needs to be kept in moist air, not submerged. Make certain that the vessel is sealed to prevent evaporation.

The storage temperature should be 0 to 30 °C (32 to 86 °F).

4. Accessories

4.1 Ordering

Telephone: 800 897 4151 (USA)

+1 937 767 7241 (Globally) Monday through Friday

8:00 AM to 5:00 ET

Fax: +1 937 767 9353 (orders)

Email: orders@ysi.com

Mail: YSI Incorporated

1725 Brannum Lane

Yellow Springs, OH 45387 USA

Web: Visit YSI.com to order replacement parts, accessories, and calibration solutions.

When placing an order please have the following available:

1. YSI account number (if available)
2. Name and phone number
3. Purchase Order or Credit Card number
4. Model Number or brief description
5. Billing and shipping addresses
6. Quantity

ProQuatro Handhelds and Kits

YSI Item #	Description
606950	ProQuatro handheld only
606966	ProQuatro handheld, 605790-4 ISE/ISE/DO/Cond/Temp cable, 605101 pH sensor, 605203 polarographic DO sensor, and 603075 soft-sided carrying case.
606967	ProQuatro handheld, 605790-4 ISE/ISE/DO/Cond/Temp cable, 605101 pH sensor, 605102 ORP sensor, 605203 polarographic DO sensor, and 603075 soft-sided carrying case.
606968	ProQuatro handheld, 605790-4 ISE/ISE/DO/Cond/Temp cable, 605101 pH sensor, 605202 galvanic DO sensor, and 603075 soft-sided carrying case.
606969	ProQuatro handheld, 605790-4 ISE/ISE/DO/Cond/Temp cable, 605101 pH sensor, 605102 ORP sensor, 605202 galvanic DO sensor, and 603075 soft-sided carrying case.

Field Cable Assemblies (length in meters)

YSI Item #	Description
605790-1, 4, 10, 20, or 30	Quatro (4 port), Dual ISE/Cond/DO/Temp. A user-replaceable conductivity/temp sensor is included with each cable. There is one DO port and two ISE ports in which sensors can be installed. DO and ISE sensors sold separately. Does not accept 1003 pH/ORP combo sensor.
6052030-1, 4, 10, 20, or 30	DO/Cond/Temp. Includes built-in conductivity and temp sensors. There is one DO port in which a DO sensor can be installed. DO sensors sold separately.
6051030-1, 4, 10, 20, or 30	ISE/Cond/Temp. Includes built-in conductivity and temp sensors. There is one ISE port in which an ISE can be installed. ISE sensors sold separately.
6051020-1, 4, 10, 20, or 30	DO/ISE/Temp. Includes a built-in temp sensor. There is one DO port and one ISE port in which sensors can be installed. DO and ISE sensors sold separately.
6051010-1, 4, 10, 20, or 30	Dual ISE/Temp. Includes a built-in temp sensor. There are two ISE ports in which sensors can be installed. ISE sensors sold separately. Does not accept 1003 pH/ORP combo sensor.
60530-1, 4, 10, 20, or 30	Cond/Temp. Includes built-in conductivity and temp sensors; no additional sensors needed.
60520-1, 4, 10, 20, 30, or 100	DO/Temp. Includes a built-in temp sensor. There is one DO port in which a DO sensor can be installed. DO sensors sold separately.
60510-1, 4, 10, 20, or 30	ISE/Temp. Includes a built-in temp sensor. There is one ISE port in which an ISE can be installed. ISE sensors sold separately. Does not accept 1003 pH/ORP combo sensor.

Sensors for Field Cables

YSI Item #	Description
605202	Galvanic DO Sensor
605203	Polarographic DO Sensor
605101	pH Sensor
605102	ORP Sensor
605103	pH/ORP Sensor (6051030 and 6051020 cables only)
605104	Ammonium ISE, NH ₄ ⁺
605105	Chloride ISE
605106	Nitrate ISE
605323	1001A Amplified pH Sensor
605216	1001A Amplified pH Sensor Kit; includes a required guard extension for 6051010 and 6051020 cables
005560	Conductivity and temperature sensor for Quatro cables; included with new Quatro cables

Lab Cable Assemblies (features built-in cables and sensors)

YSI Item #	Description
605780	DO/Temp 115V stirring BOD probe with 1-meter cable assembly
605107	pH/Temp single junction combination electrode with 1-meter cable w/MS connector
605177	pH/Temp single junction combination electrode with 4-meter cable w/MS connector
605108	ORP/Temp single junction combination electrode with 1-meter cable w/MS connector
605178	ORP/Temp single junction combination electrode with 4-meter cable w/MS connector
605109	pH/ORP/Temp single junction combination electrode with 1-meter cable w/MS connector
605179	pH/ORP/Temp single junction combination electrode with 4-meter cable w/MS connector

Other Accessories

YSI Item #	Description
603075	Carrying Case, Soft Sided
603074	Carrying Case, Hard Sided
603162	Carrying Case, Soft Sided, Small
603069	Belt Clip
063517	Ultra Clamp
063507	Tripod Clamp
603070	Shoulder Strap
606850	Flow cell for Quatro cable

Calibration Solutions

YSI Item #	Description
060907	Conductivity Calibrator, 1,000 umhos/cm (8 ea, pint)
060911	Conductivity Calibrator, 10,000 umhos/cm (8 ea, pint)
060660	Conductivity Calibrator, 50,000 umhos/cm (8 ea, pint)
061320	Zobell Solution, ORP Calibrator 125 mL
061321	Zobell Solution, ORP Calibrator 250 mL
061322	Zobell Solution, ORP Calibrator 500 mL
003821	pH 4 Buffer (box of 6 pints)
003822	pH 7 Buffer (box of 6 pints)
003823	pH 10 Buffer (box of 6 pints)
603824	pH Buffer, Assorted Case
003841	Ammonium Cal Solution, 1 mg/L (500mL)
003842	Ammonium Cal Solution, 10 mg/L (500mL)
003843	Ammonium Cal Solution, 100 mg/L (500mL)
003885	Nitrate Standard, 1 mg/L (500mL)
003886	Nitrate Standard, 10 mg/L (500mL)
003887	Nitrate Standard, 100 mg/L (500mL)

Replacement Parts

YSI Item #	Description
626992	USB 2.0 cable for connection to a USB flash drive; included with new ProQuatro instruments
005560	Conductivity and temperature sensor for Quatro cables; included with new Quatro cables

5. Safety and Support

5.1 Service Information

YSI has authorized service centers throughout the United States and Internationally. For the nearest service center information, please visit ysi.com and click 'Support' or contact YSI Technical Support directly at 800-897-4151 (+1 937-767-7241).

When returning a product for service, include the Product Return form with cleaning certification. The form must be completely filled out for a YSI Service Center to accept the instrument for service. The form may be downloaded from YSI.com.

5.2 Technical Support

Telephone: 800 897 4151 (USA)

+1 937 767 7241 (Globally) Monday through Friday, 8:00 AM to 5:00 ET

Fax: +1 937 767 9353 (orders)

Email: info@ysi.com

Mail: YSI Incorporated

1725 Brannum Lane

Yellow Springs, OH 45387 USA

Internet: YSI.com

5.3

Declaration of Conformity

The undersigned hereby declares that the products listed below conform to all applicable Essential Requirements of the Listed Directives and Standards and carry the CE mark accordingly.

<i>Manufacturer:</i>	YSI Incorporated 1725 Brannum Lane Yellow Springs, OH 45387 USA
<i>Product Name:</i>	ProQuatro Water Quality Instrument
<i>Model Number:</i>	ProQuatro - 606950
<i>Sensors:</i>	605107, 605108, 605109, 605177, 605178, 605179, 605202, 605203, 605323, 605324, 605780
<i>Cables:</i>	60510-xx, 60520-xx, 60530-xx, 6051010-xx, 6051020-xx, 6051030-xx, 6052030-xx
<i>Accessories:</i>	626444
<i>Conforms to the following:</i>	
<i>Directives:</i>	EMC 2014/30/EU LVD 2014/35/EU WEEE 2012/19/EU RoHS 2011/65/EU
<i>Harmonized Standards:</i>	EN61326-1:2013 EN61326-2-3:2013 EN61000-3-2:2014 EN61000-3-3:2013 EN55011:2009
<i>Authorized EU Representative</i>	Xylem Analytics UK Ltd Unit 2 Focal Point, Lacerta Court, Works Road Letchworth, Hertfordshire, SG6 1FJ UK

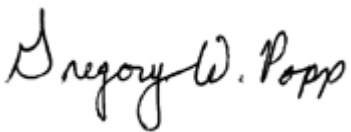

Signed: Gregory Popp
Title: Quality Manager

Date: March 3, 2020

The undersigned hereby declares on behalf of the named manufacturer under our sole responsibility that the listed product conforms to the requirements for electrical equipment under US FCC Part 15 and ICES-003 for unintentional radiators.

<i>Manufacturer:</i>	YSI Incorporated 1725 Brannum Lane Yellow Springs, OH 45387 USA
<i>Product Name:</i>	ProQuatro Water Quality Instrument
<i>Model Number:</i>	ProQuatro - 606950
<i>Sensors:</i>	605107, 605108, 605109, 605177, 605178, 605179, 605202, 605203, 605323, 605324, 605780
<i>Cables:</i>	60510-xx, 60520-xx, 60530-xx, 6051010-xx, 6051020-xx, 6051030-xx, 6052030-xx
<i>Accessories:</i>	626444
<i>Conforms to the following:</i>	
<i>Regulations:</i>	<ul style="list-style-type: none"> • FCC 47 CFR Part 15-2008, Subpart B, Class B, Radio Frequency Devices • ICES-003:2004, Digital Apparatus



Signed: Gregory Popp
Title: Quality Manager

Date: March 3, 2020

5.4

Warranty

The YSI ProQuatro is warranted for three (3) years from date of purchase by the end user against defects in materials and workmanship, exclusive of batteries and any damage caused by defective batteries. ProQuatro field cables are warranted for two (2) years from date of purchase by the end user against defects in material and workmanship (6 months for non-field rugged cables*). ProQuatro sensors (pH, ORP, pH/ORP combo, Polarographic DO) are warranted for one (1) year from date of purchase by the end user against defects in material and workmanship (6 months for ammonium**, nitrate**, chloride**, and Galvanic DO). ProQuatro systems (instrument, cables & sensors) are warranted for 90 days from date of purchase by the end user against defects in material and workmanship when purchased by rental agencies for rental purposes. Within the warranty period, YSI will repair or replace, at its sole discretion, free of charge, any product that YSI determines to be covered by this warranty.

To exercise this warranty, call your local YSI representative, or contact YSI Technical Support in Yellow Springs, Ohio at +1 937 767-7241, 800-897-4151 or visit <https://www.ysi.com/customer-support/product-service> for a Product Return Form. Send the product and proof of purchase, transportation prepaid, to the Authorized Service Center selected by YSI. Repair or replacement will be made and the product returned, transportation prepaid. Repaired or replaced products are warranted for the balance of the original warranty period, or at least 90 days from date of repair or replacement.

LIMITATION OF WARRANTY

This Warranty does not apply to any YSI product damage or failure caused by:

1. Failure to install, operate or use the product in accordance with YSI's written instructions;
2. Abuse or misuse of the product;
3. Failure to maintain the product in accordance with YSI's written instructions or standard industry procedure;
4. Any improper repairs to the product;
5. Use by you of defective or improper components or parts in servicing or repairing the product;
6. Modification of the product in any way not expressly authorized by YSI.

THIS WARRANTY IS IN LIEU OF ALL OTHER WARRANTIES, EXPRESSED OR IMPLIED, INCLUDING ANY WARRANTY OF MERCHANTABILITY OR FITNESS FOR A PARTICULAR PURPOSE. YSI's LIABILITY UNDER THIS WARRANTY IS LIMITED TO REPAIR OR REPLACEMENT OF THE PRODUCT, AND THIS SHALL BE YOUR SOLE AND EXCLUSIVE REMEDY FOR ANY DEFECTIVE PRODUCT COVERED BY THIS WARRANTY. IN NO EVENT SHALL YSI BE LIABLE FOR ANY SPECIAL, INDIRECT, INCIDENTAL OR CONSEQUENTIAL DAMAGES RESULTING FROM ANY DEFECTIVE PRODUCT COVERED BY THIS WARRANTY.

* The warranty period for the non-field rugged cables (605107, 605177, 605108, 605178, 605109, 605179) is listed as 6 months. However, the true "working life" of these sensors may be 3-9 months depending on storage and usage in solutions other than clean aqueous samples.

** The warranty for the ammonium, nitrate, and chloride sensors (605104, 605105, 605106) is listed as 6 months. However, the true "working life" of these sensors may be 3-9 months depending on storage and usage in solutions other than clean aqueous samples.

6. Appendices

6.1

Appendix A DO% Calibration Values

Calibration Value	Pressure			
	D.O. %	in Hg	mmHg	kPa
101%	30.22	767.6	102.34	1023.38
100%	29.92	760.0	101.33	1013.25
99%	29.62	752.4	100.31	1003.12
98%	29.32	744.8	99.30	992.99
97%	29.02	737.2	98.29	982.85
96%	28.72	729.6	97.27	972.72
95%	28.43	722.0	96.26	962.59
94%	28.13	714.4	95.25	952.46
93%	27.83	706.8	94.23	942.32
92%	27.53	699.2	93.22	932.19
91%	27.23	691.6	92.21	922.06
90%	26.93	684.0	91.19	911.93
89%	26.63	676.4	90.18	901.79
88%	26.33	668.8	89.17	891.66
87%	26.03	661.2	88.15	881.53
86%	25.73	653.6	87.14	871.40
85%	25.43	646.0	86.13	861.26
84%	25.13	638.4	85.11	851.13
83%	24.83	630.8	84.10	841.00
82%	24.54	623.2	83.09	830.87
81%	24.24	615.6	82.07	820.73
80%	23.94	608.0	81.06	810.60
79%	23.64	600.4	80.05	800.47
78%	23.34	592.8	79.03	790.34
77%	23.04	585.2	78.02	780.20
76%	22.74	577.6	77.01	770.07
75%	22.44	570.0	75.99	759.94
74%	22.14	562.4	74.98	749.81
73%	21.84	554.8	73.97	739.67
72%	21.54	547.2	72.95	729.54

6.2

Appendix B Oxygen Solubility Table

Solubility of oxygen in mg/L in water exposed to water-saturated air at 760 mm Hg pressure.

Salinity = Measure of quantity of dissolved salts in water.

Chlorinity = Measure of chloride content, by mass, of water.

$$S(0/00) = 1.80655 \times \text{Chlorinity (0/00)}$$

Temp °C	Chlorinity : 0 Salinity: 0	5.0 ppt 9.0 ppt	10.0 ppt 18.1 ppt	15.0 ppt 27.1 ppt	20.0 ppt 36.1 ppt	25.0 ppt 45.2 ppt
0.0	14.62	13.73	12.89	12.10	11.36	10.66
1.0	14.22	13.36	12.55	11.78	11.07	10.39
2.0	13.83	13.00	12.22	11.48	10.79	10.14
3.0	13.46	12.66	11.91	11.20	10.53	9.90
4.0	13.11	12.34	11.61	10.92	10.27	9.66
5.0	12.77	12.02	11.32	10.66	10.03	9.44
6.0	12.45	11.73	11.05	10.40	9.80	9.23
7.0	12.14	11.44	10.78	10.16	9.58	9.02
8.0	11.84	11.17	10.53	9.93	9.36	8.83
9.0	11.56	10.91	10.29	9.71	9.16	8.64
10.0	11.29	10.66	10.06	9.49	8.96	8.45
11.0	11.03	10.42	9.84	9.29	8.77	8.28
12.0	10.78	10.18	9.62	9.09	8.59	8.11
13.0	10.54	9.96	9.42	8.90	8.41	7.95
14.0	10.31	9.75	9.22	8.72	8.24	7.79
15.0	10.08	9.54	9.03	8.54	8.08	7.64
16.0	9.87	9.34	8.84	8.37	7.92	7.50
17.0	9.67	9.15	8.67	8.21	7.77	7.36
18.0	9.47	8.97	8.50	8.05	7.62	7.22
19.0	9.28	8.79	8.33	7.90	7.48	7.09
20.0	9.09	8.62	8.17	7.75	7.35	6.96
21.0	8.92	8.46	8.02	7.61	7.21	6.84
22.0	8.74	8.30	7.87	7.47	7.09	6.72
23.0	8.58	8.14	7.73	7.34	6.96	6.61
24.0	8.42	7.99	7.59	7.21	6.84	6.50
25.0	8.26	7.85	7.46	7.08	6.72	6.39
26.0	8.11	7.71	7.33	6.96	6.62	6.28
27.0	7.97	7.58	7.20	6.85	6.51	6.18
28.0	7.83	7.44	7.08	6.73	6.40	6.09
29.0	7.69	7.32	6.93	6.62	6.30	5.99
30.0	7.56	7.19	6.85	6.51	6.20	5.90
31.0	7.43	7.07	6.73	6.41	6.10	5.81
32.0	7.31	6.96	6.62	6.31	6.01	5.72

Temp °C	Chlorinity : 0 Salinity: 0	5.0 ppt 9.0 ppt	10.0 ppt 18.1 ppt	15.0 ppt 27.1 ppt	20.0 ppt 36.1 ppt	25.0 ppt 45.2 ppt
33.0	7.18	6.84	6.52	6.21	5.91	5.63
34.0	7.07	6.73	6.42	6.11	5.82	5.55
35.0	6.95	6.62	6.31	6.02	5.73	5.46
36.0	6.84	6.52	6.22	5.93	5.65	5.38
37.0	6.73	6.42	6.12	5.84	5.56	5.31
38.0	6.62	6.32	6.03	5.75	5.48	5.23
39.0	6.52	6.22	5.98	5.66	5.40	5.15
40.0	6.41	6.12	5.84	5.58	5.32	5.08
41.0	6.31	6.03	5.75	5.49	5.24	5.01
42.0	6.21	5.93	5.67	5.41	5.17	4.93
43.0	6.12	5.84	5.58	5.33	5.09	4.86
44.0	6.02	5.75	5.50	5.25	5.02	4.79
45.0	5.93	5.67	5.41	5.17	4.94	4.72

Xylem |'zīləm|

- 1) The tissue in plants that brings water upward from the roots;
- 2) a leading global water technology company.



We're a global team unified in a common purpose: creating advanced technology solutions to the world's water challenges. Developing new technologies that will improve the way water is used, conserved, and re-used in the future is central to our work. Our products and services move, treat, analyze, monitor and return water to the environment, in public utility, industrial, residential and commercial building services settings. Xylem also provides a leading portfolio of smart metering, network technologies and advanced analytics solutions for water, electric and gas utilities. In more than 150 countries, we have strong, long-standing relationships with customers who know us for our powerful combination of leading product brands and applications expertise with a strong focus on developing comprehensive, sustainable solutions.

For more information on how Xylem can help you, go to www.xylem.com

Who's
Minding
the Planet?®

xylem
Let's Solve Water

YSI, a Xylem brand
1725 Brannum Lane
Yellow Springs, OH 45387

 +1.937.767.7241
 info@ysi.com
 ysi.com



YSI.com/ProQuatro